

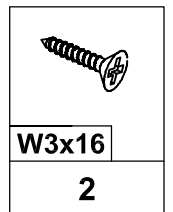

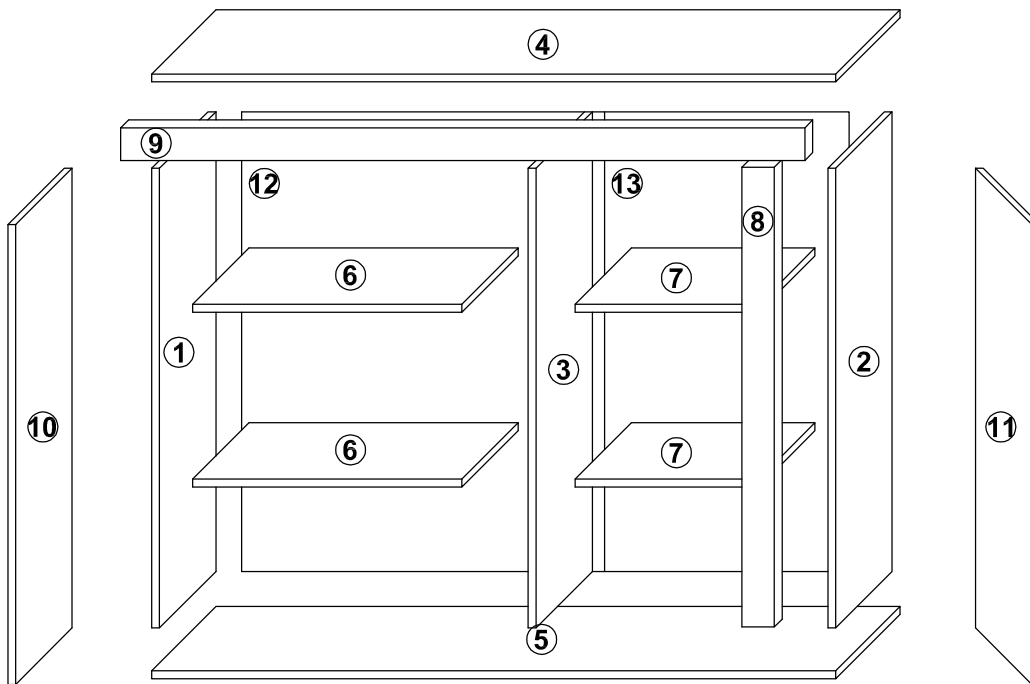

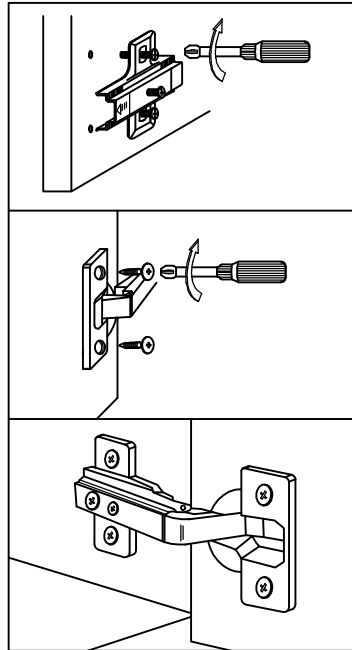

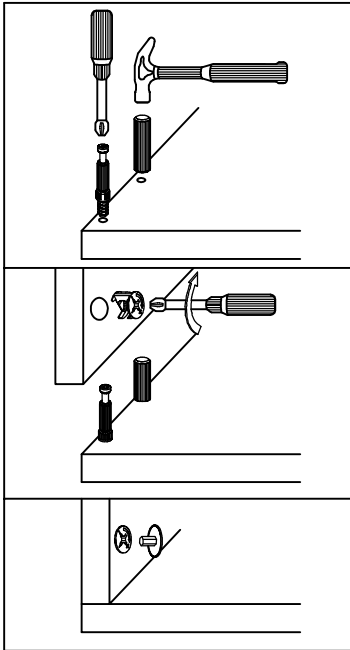

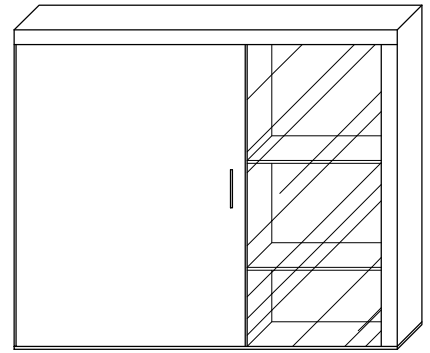
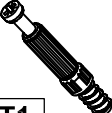

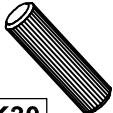
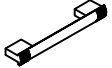

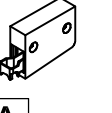
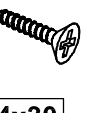
# DAMIS - REG1D1W

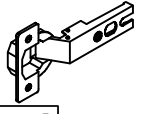

								
T1	M1	Z1	K30	U1	W4x27	K10x16	ZA	W4x30
20	20	20	20	1	2	3	3	6
								
OBPN	G2	W4x16	P2	ZRS	PZRS	ZP	PZ	PP
1	40	14	10	2	2	2	2	16

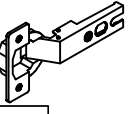
1

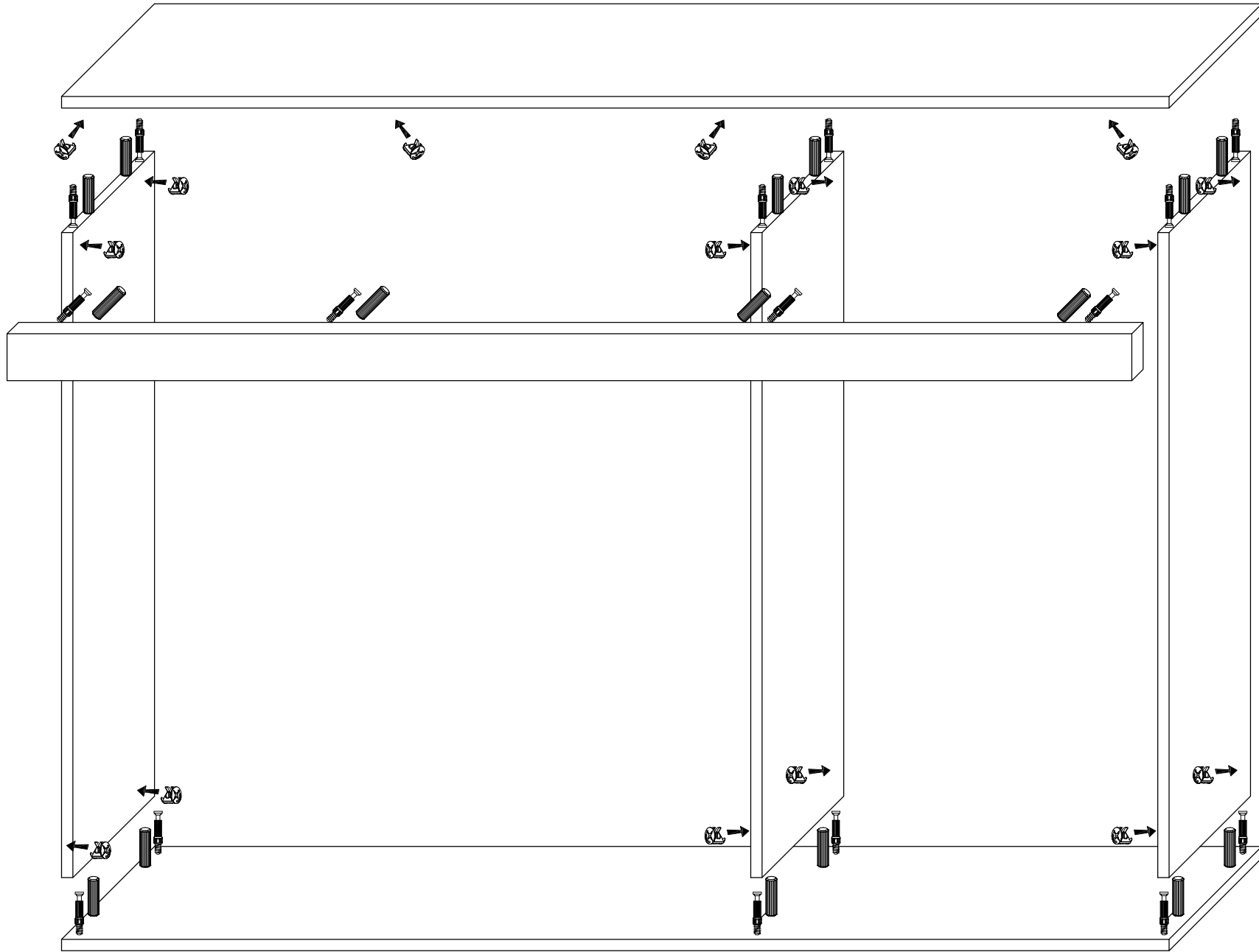

2

