

Adam

Typ A

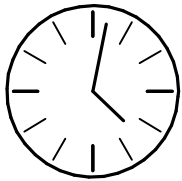

90 min

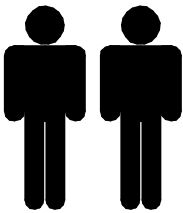

2025 mm

410 mm

537 mm

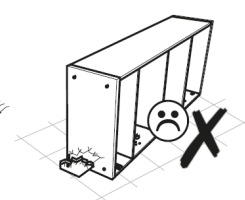
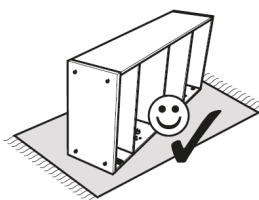
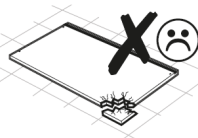
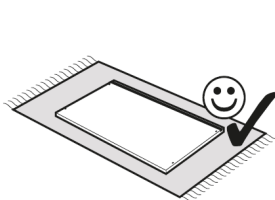
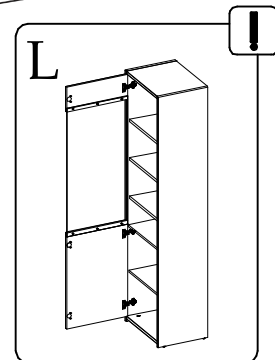
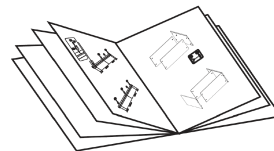
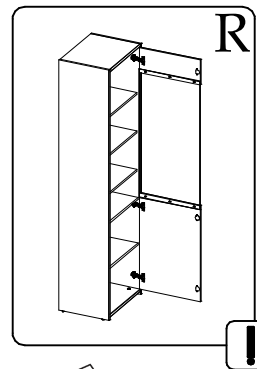
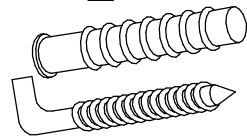
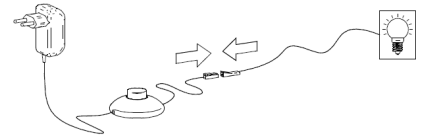

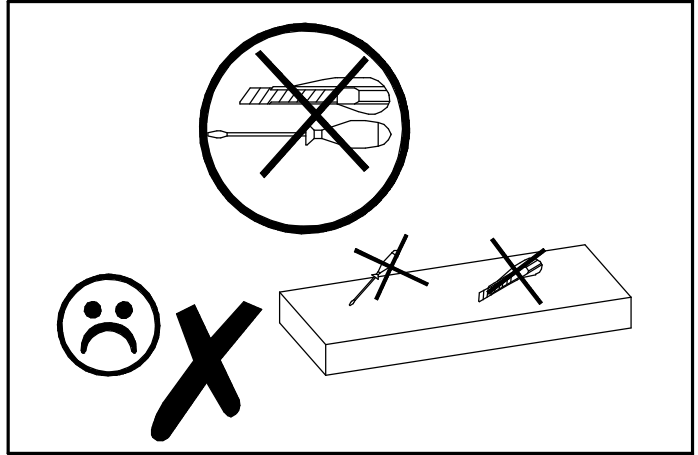
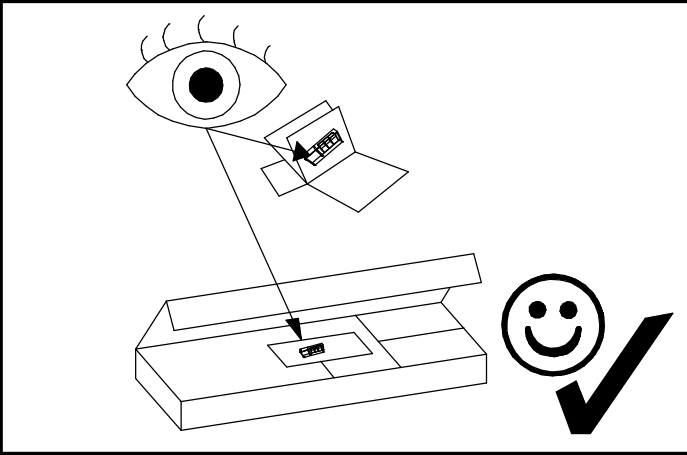

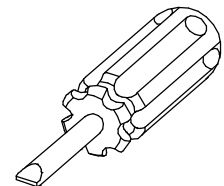
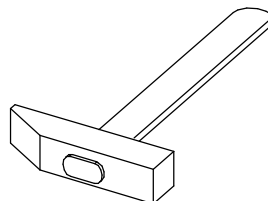
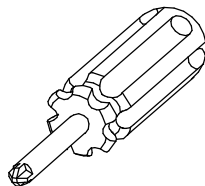
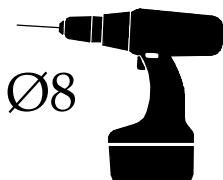
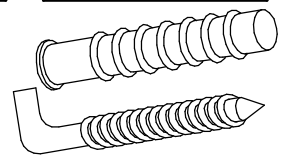
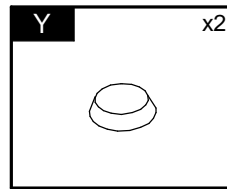
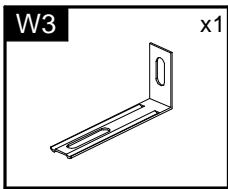
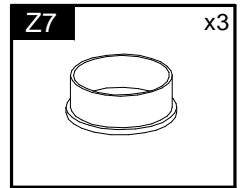
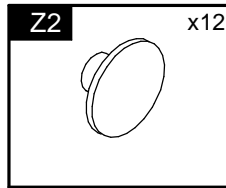
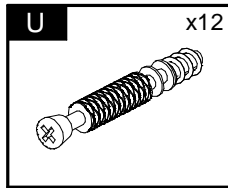
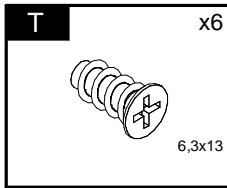
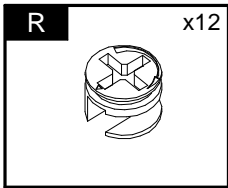
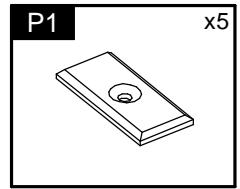
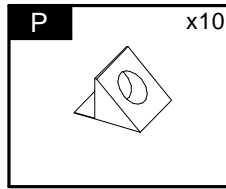
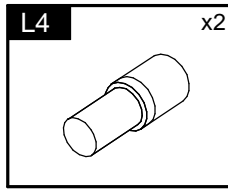
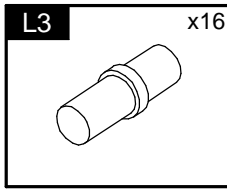
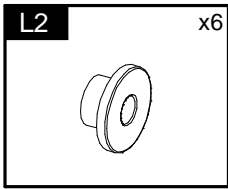
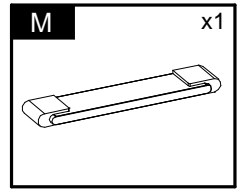
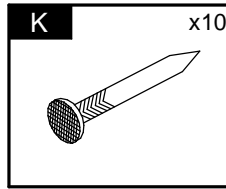
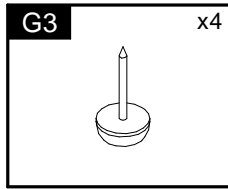
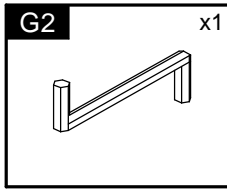
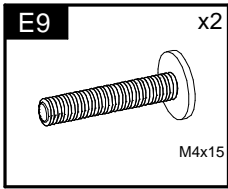
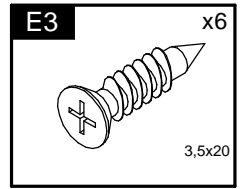
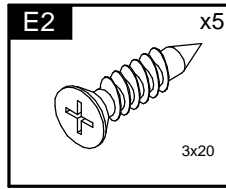
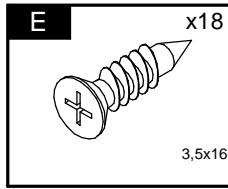
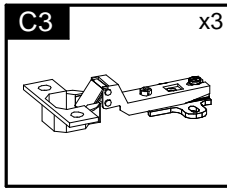
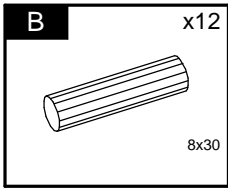
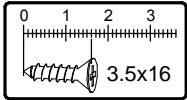

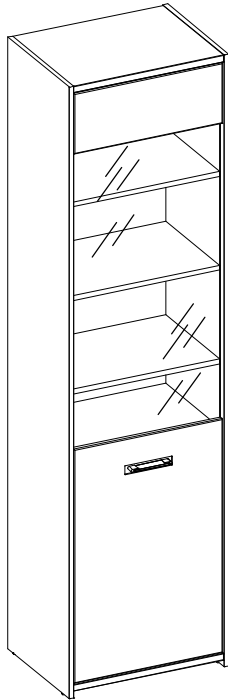

Element symbol	Measurements				Code	Paket
1	505	407.5	22	1	1005	1/3
2	505	387.5	22	1	1004	1/3
3	2020	409.5	16	1	1002	1/3
4	2020	409.5	16	1	1003	1/3
5	505	369.5	16	1	1012	2/3
6	505	355	16	1	N/A	1/3
7	505	355	16	1	N/A	1/3
8	505	355	16	1	N/A	1/3
9	505	368.5	16	1	N/A	1/3
10	1233.5	259.5	3	2	N/A	1/3
11	748.5	519	3	1	N/A	2/3
12	502	203	16	2	1015/3001	2/3
13	775	502	16	1	1016/3002	2/3
14	1035	500	4	1	Glass	3/3

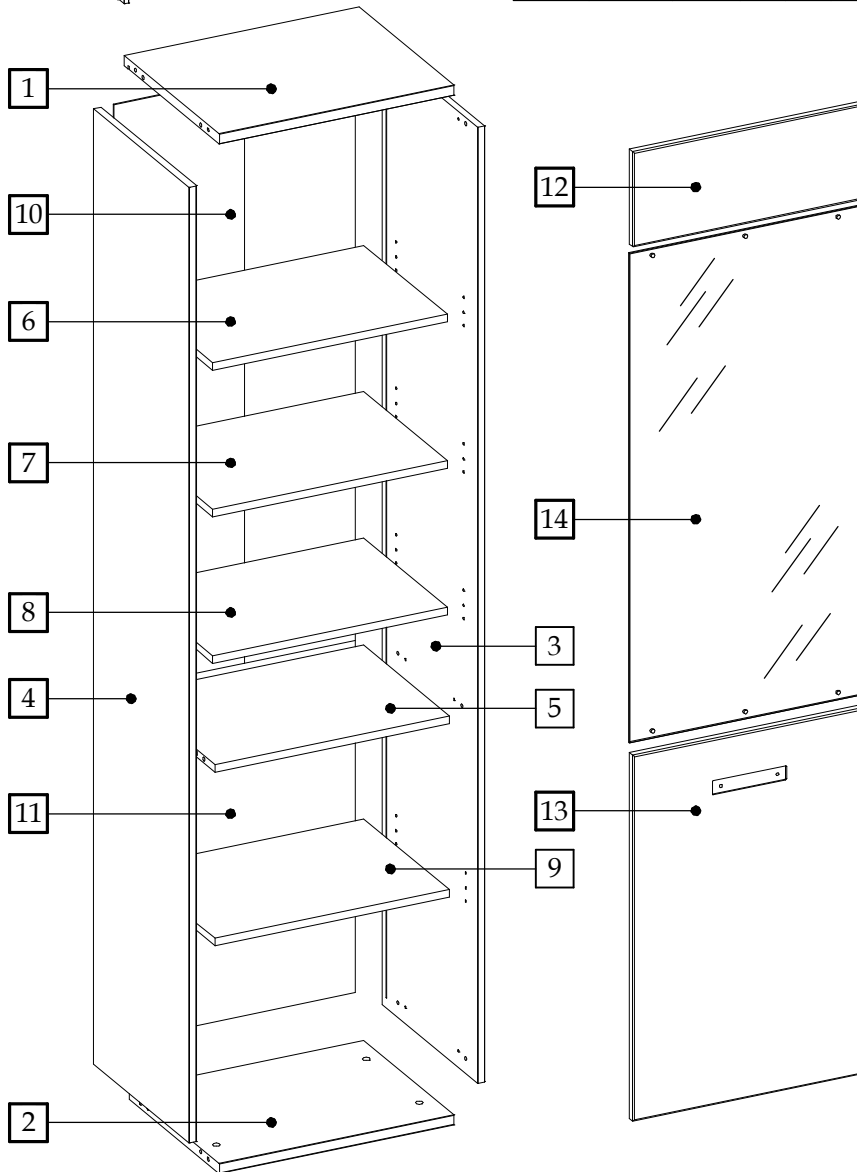

2

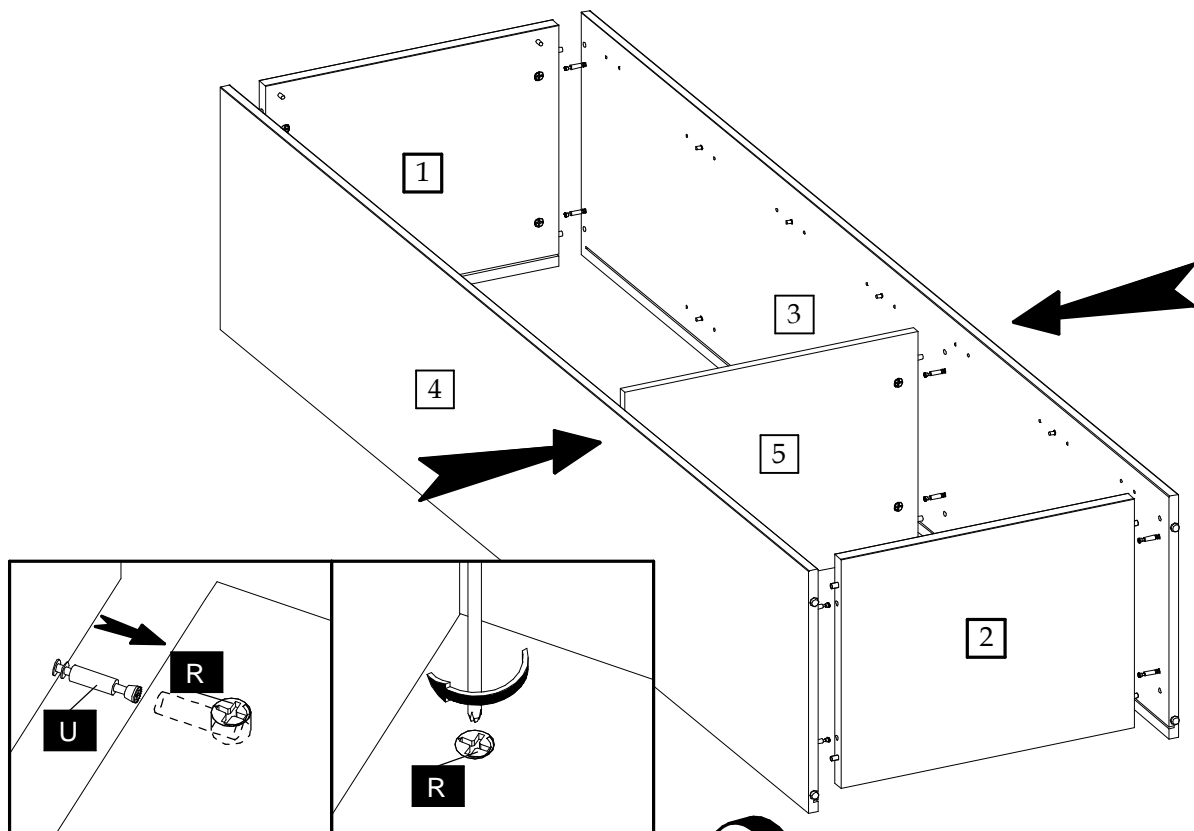

3

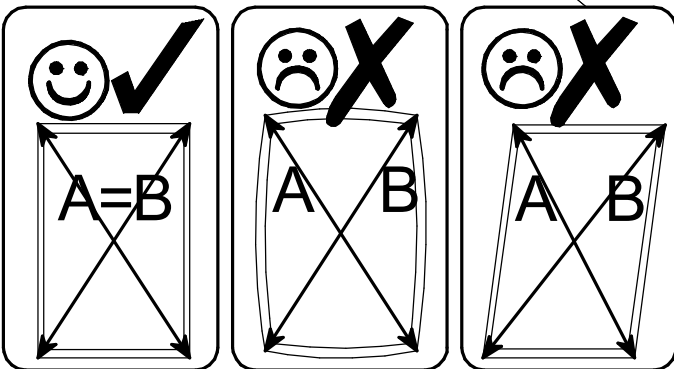
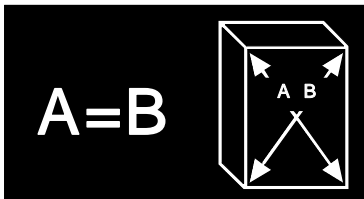
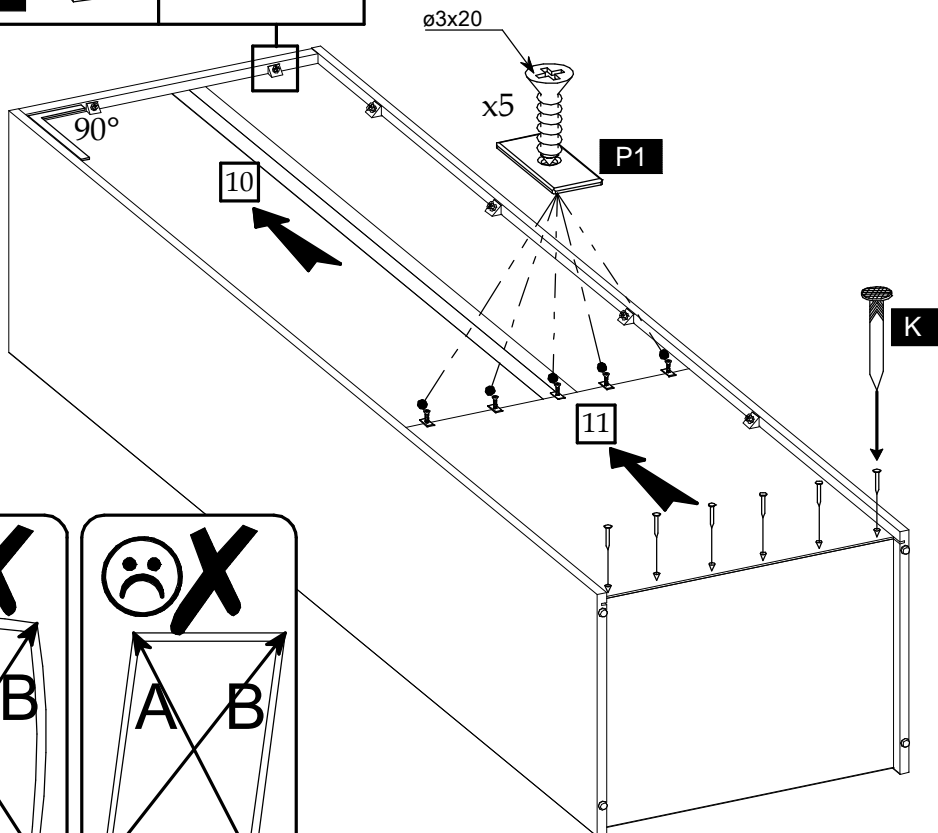
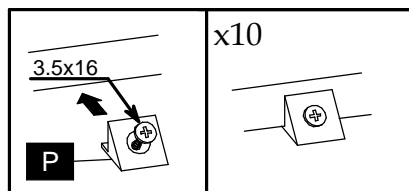

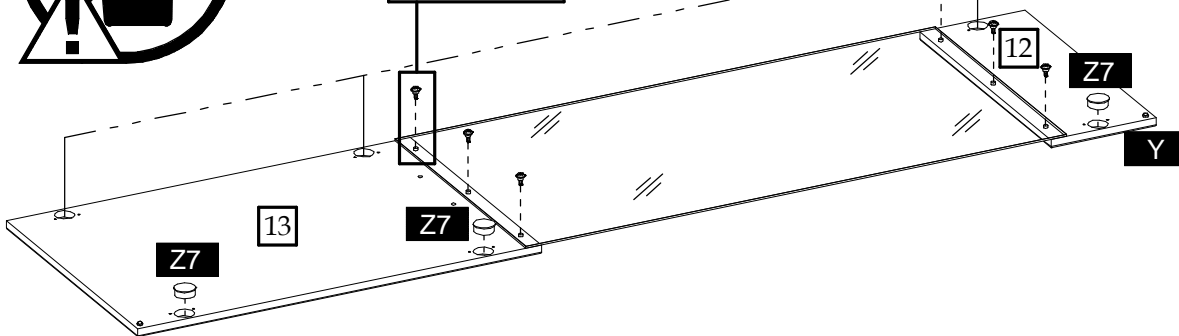
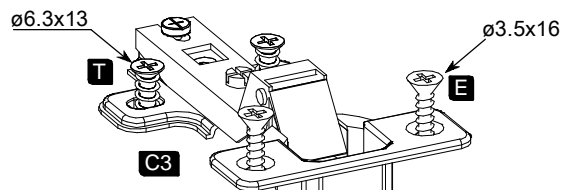
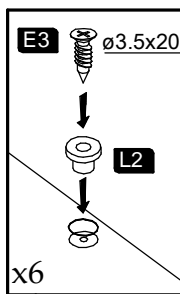
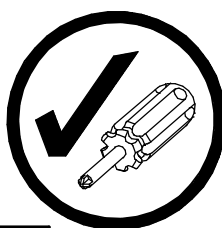
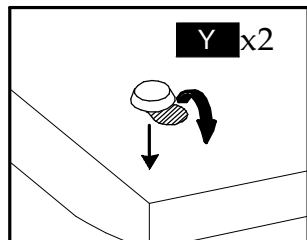
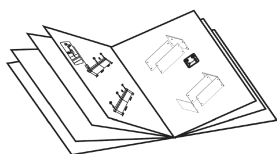
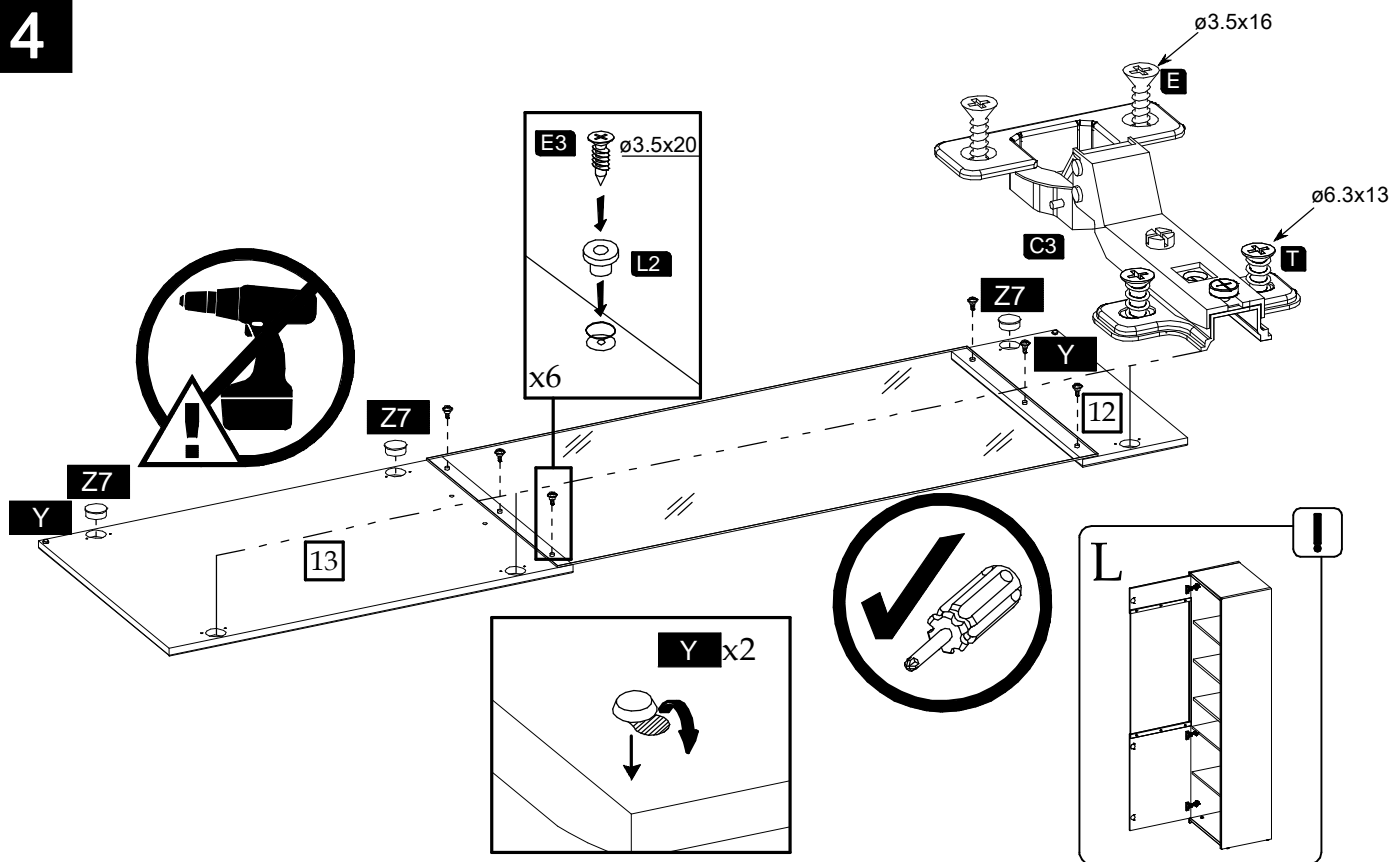

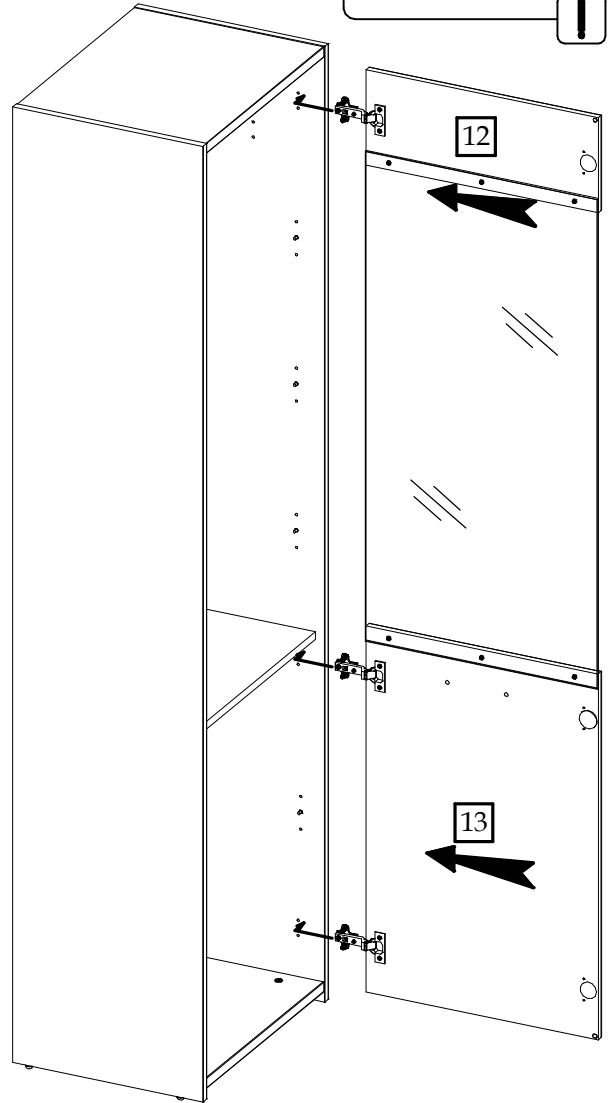
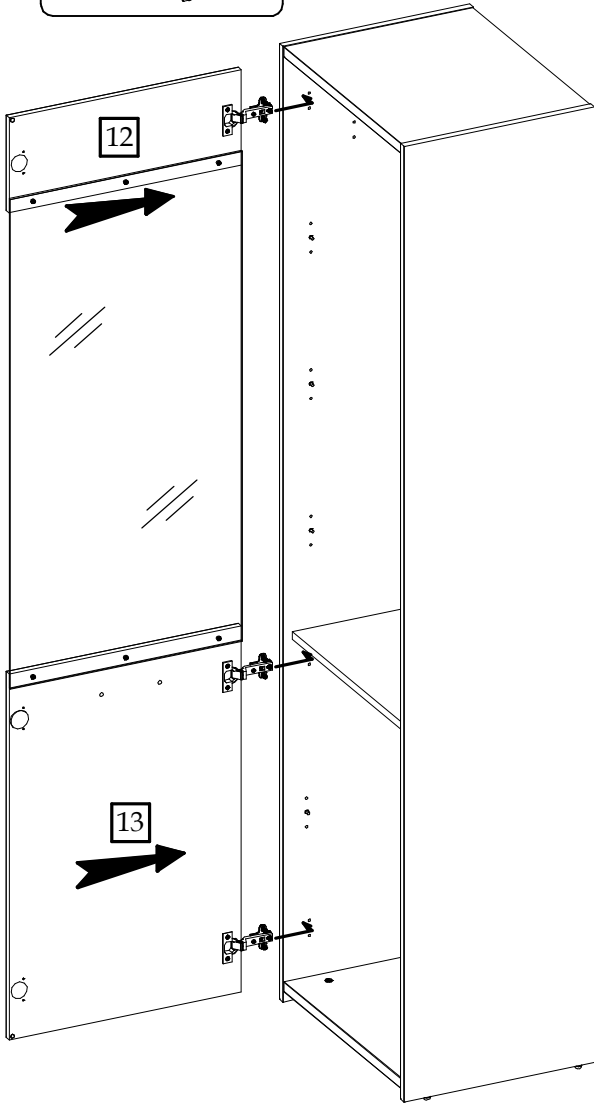
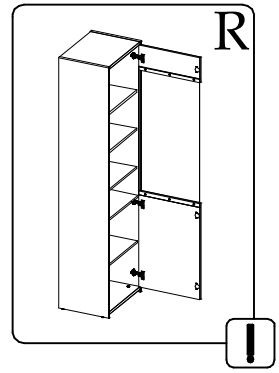
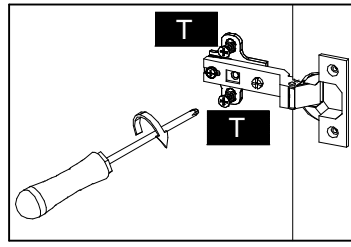
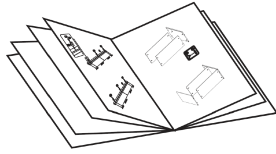
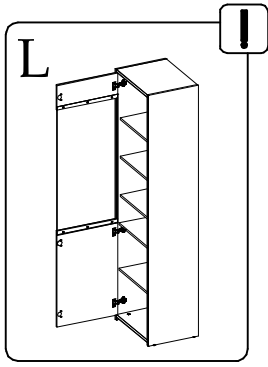

<p>+ 2 mm - 2 mm</p>	<p>+ 3 mm - 1 mm</p>	<p>+ 5 mm - 1,5 mm</p>

