

VIGO

Typ S

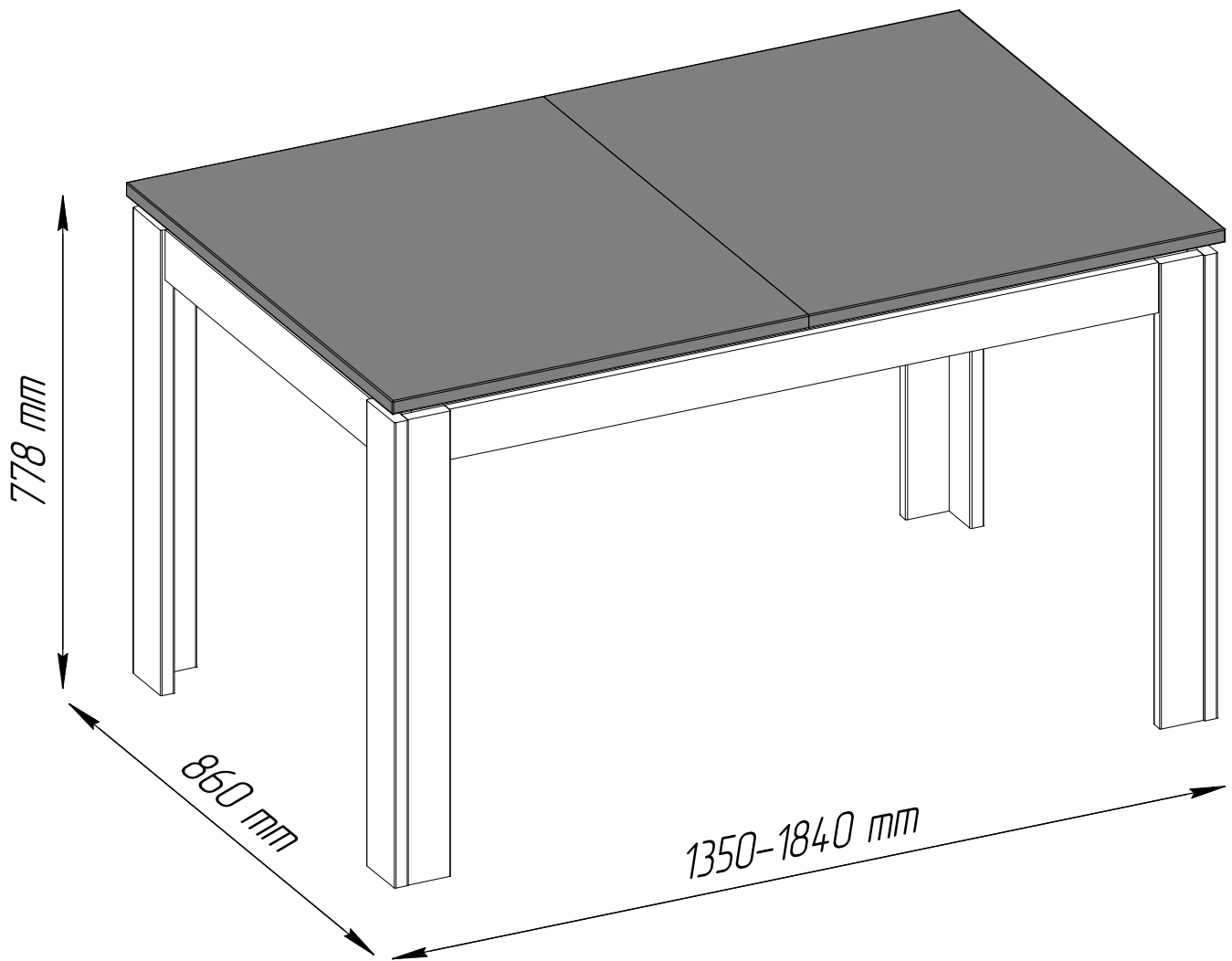

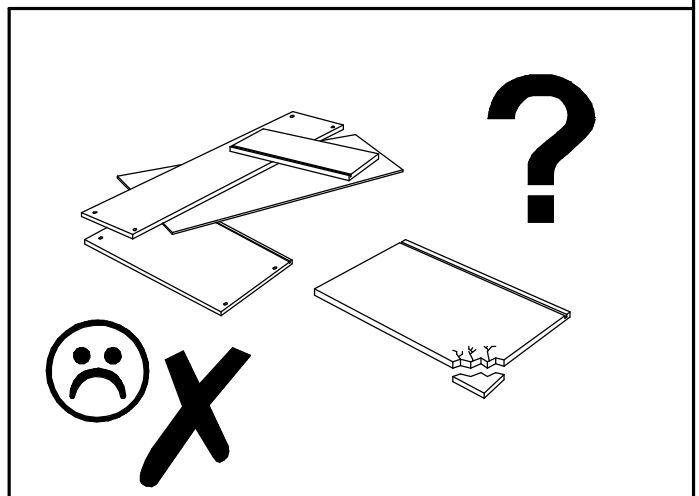

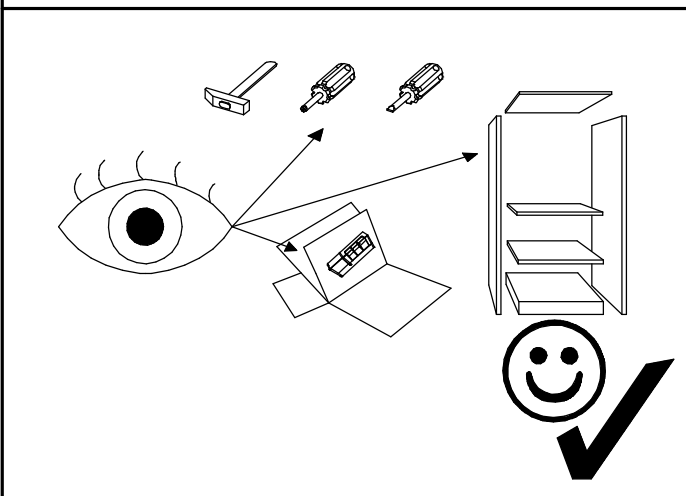
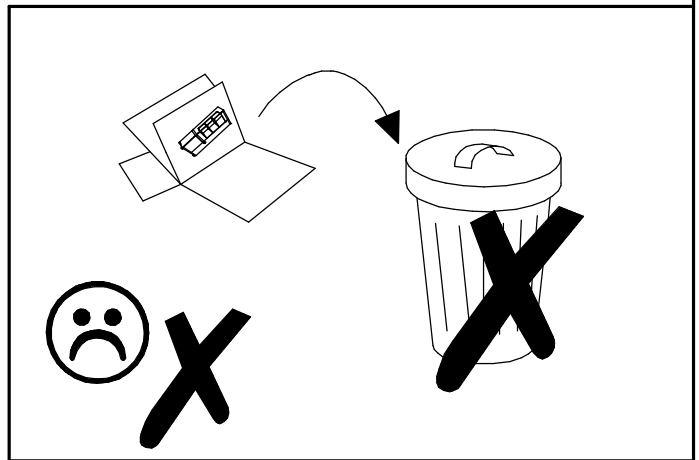
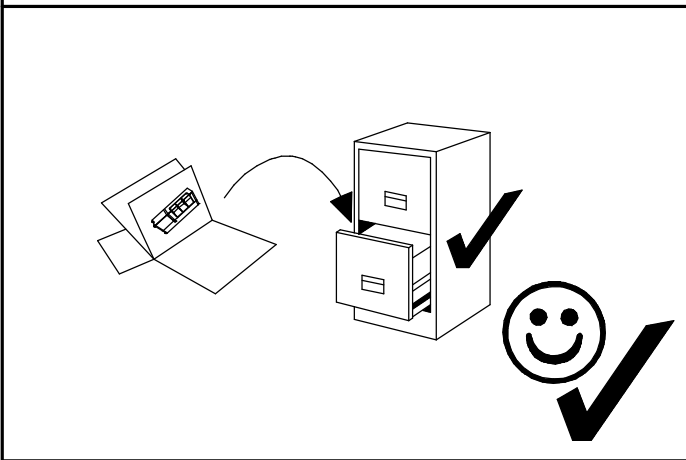
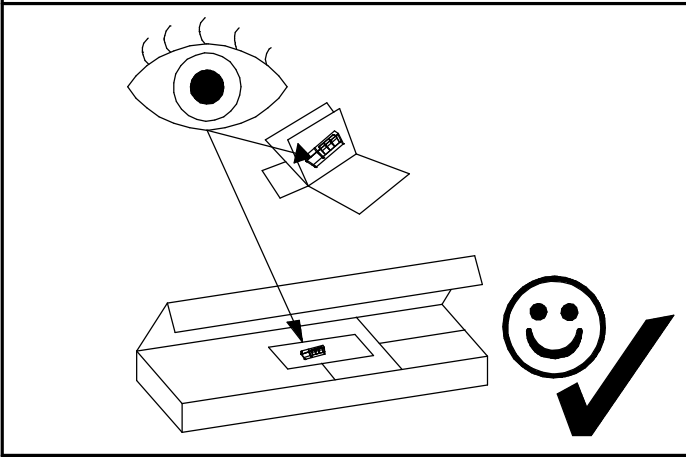
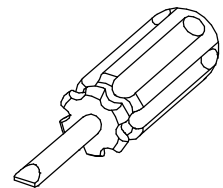
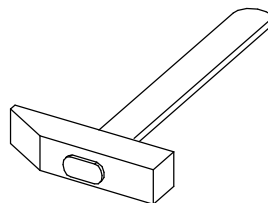
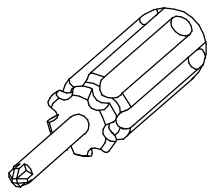
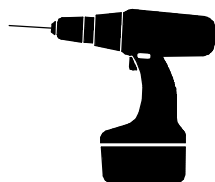
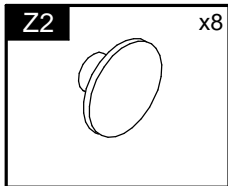
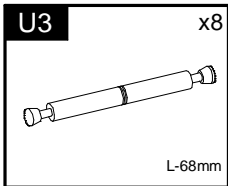
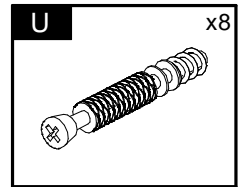
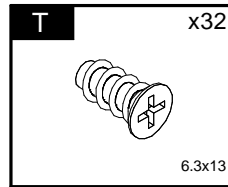
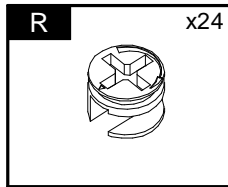
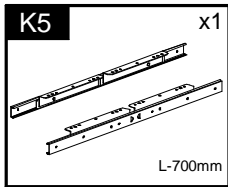
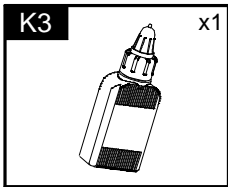
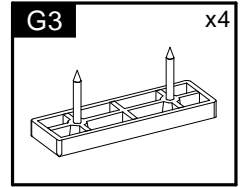
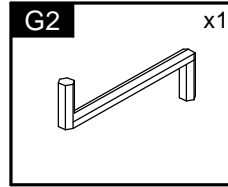
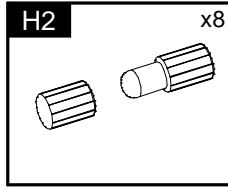
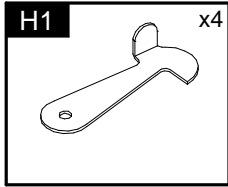
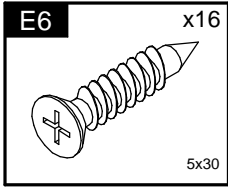
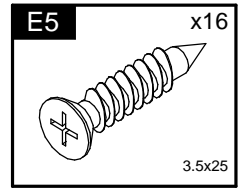
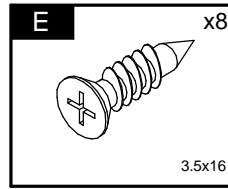
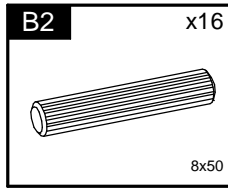
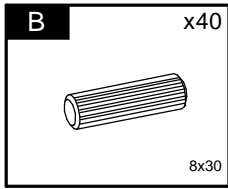
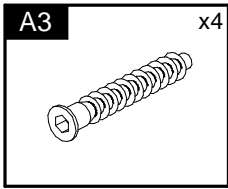
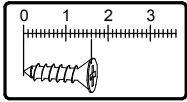
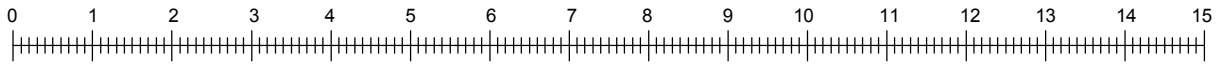

| Element symbol | Measurements | | | | Code | Paket |
|----------------|--------------|-----|----|---|------|-------|
| 1 | 675 | 860 | 22 | 1 | 1016 | 1/2 |
| 2 | 675 | 860 | 22 | 1 | 1017 | 1/2 |
| 3 | 490 | 860 | 22 | 1 | 1018 | 1/2 |
| 4 | 740 | 92 | 22 | 1 | 1003 | 1/2 |
| 5 | 740 | 92 | 22 | 1 | 1004 | 1/2 |
| 6 | 740 | 70 | 22 | 1 | 1005 | 1/2 |
| 7 | 740 | 70 | 22 | 1 | 1006 | 1/2 |
| 8 | 740 | 70 | 22 | 1 | 1012 | 1/2 |
| 9 | 740 | 70 | 22 | 1 | 1013 | 1/2 |
| 10 | 740 | 92 | 22 | 1 | 1014 | 1/2 |

| Element symbol | Measurements | | | | Code | Paket |
|----------------|--------------|----|----|---|------|-------|
| 11 | 740 | 92 | 22 | 1 | 1015 | 1/2 |
| 12 | 767 | 92 | 16 | 1 | 1009 | 1/2 |
| 13 | 767 | 92 | 16 | 1 | 1010 | 1/2 |
| 14 | 799 | 92 | 16 | 1 | 1011 | 1/2 |
| 15 | 799 | 92 | 16 | 1 | 1007 | 1/2 |
| 16 | 1257 | 92 | 16 | 1 | 1001 | 2/2 |
| 17 | 1257 | 92 | 16 | 1 | 1008 | 2/2 |
| 18 | 663 | 80 | 16 | 2 | 1020 | 1/2 |
| 19 | 1149 | 80 | 16 | 2 | 1022 | 1/2 |

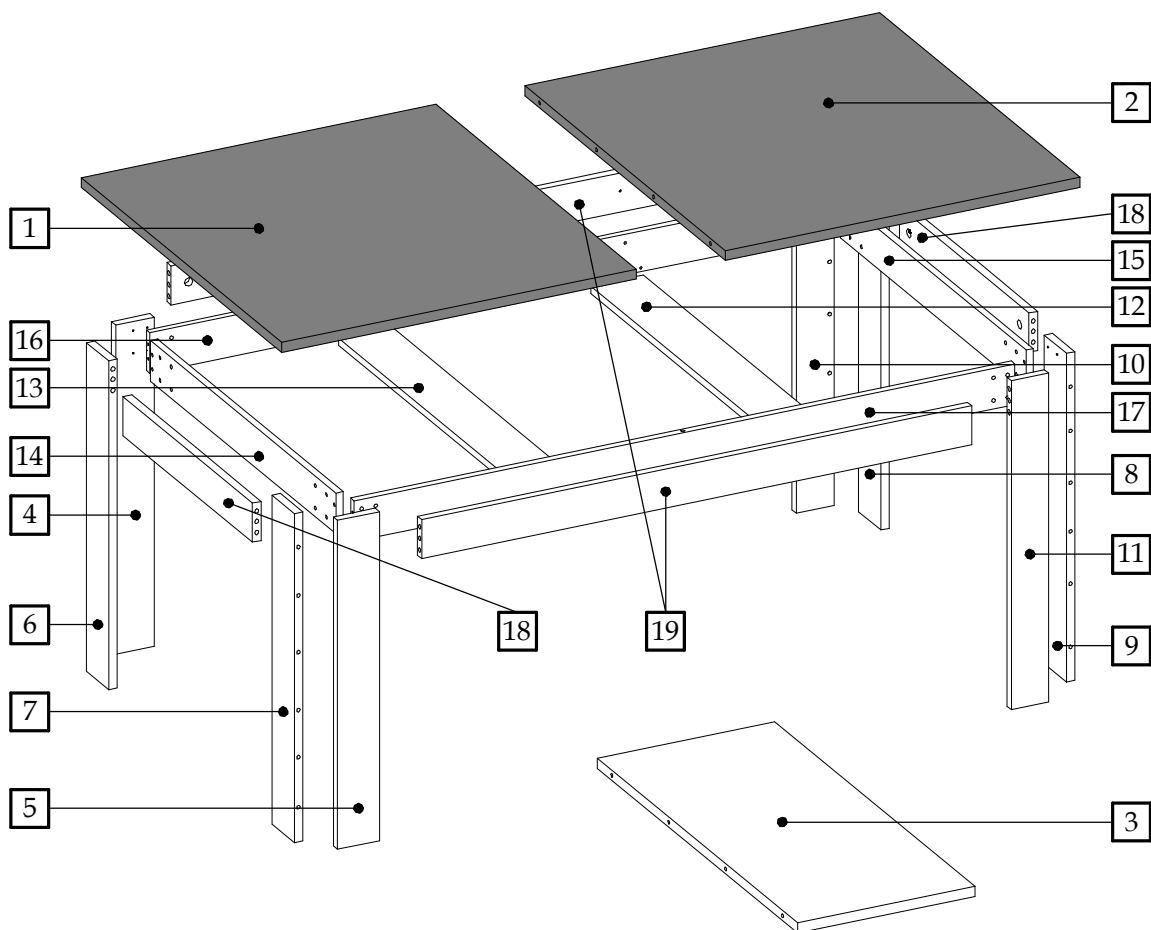



1

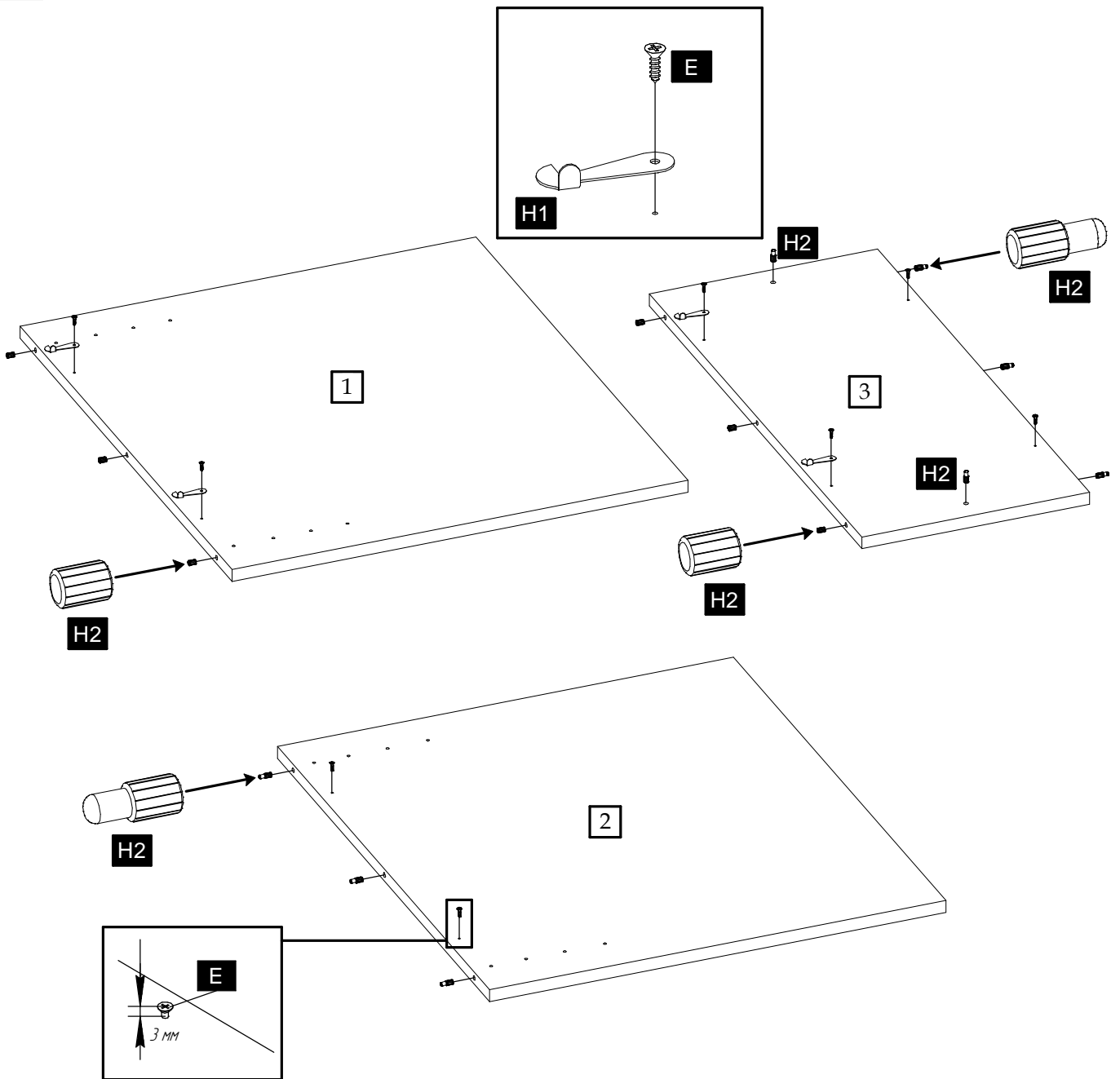

2

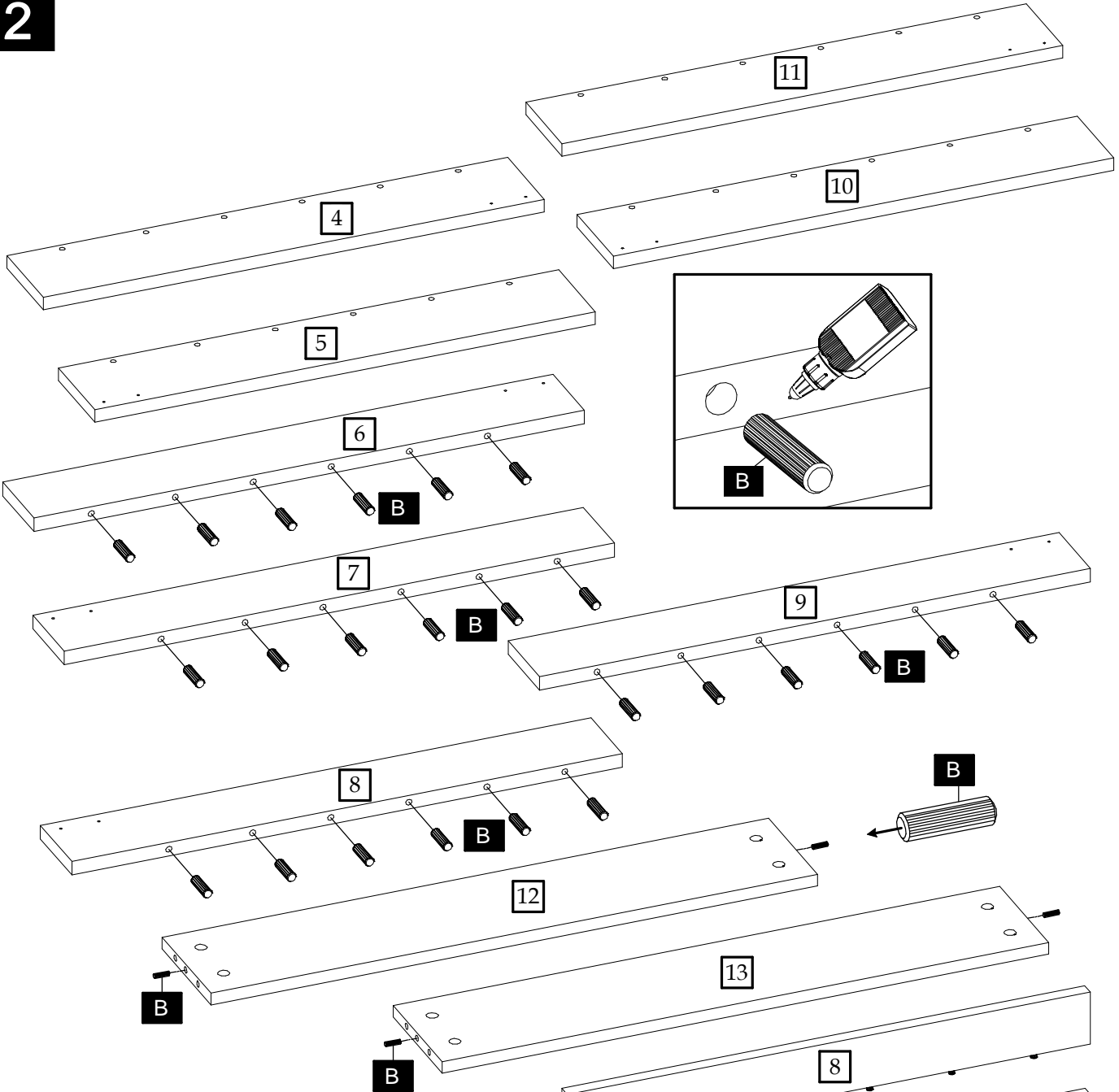

3

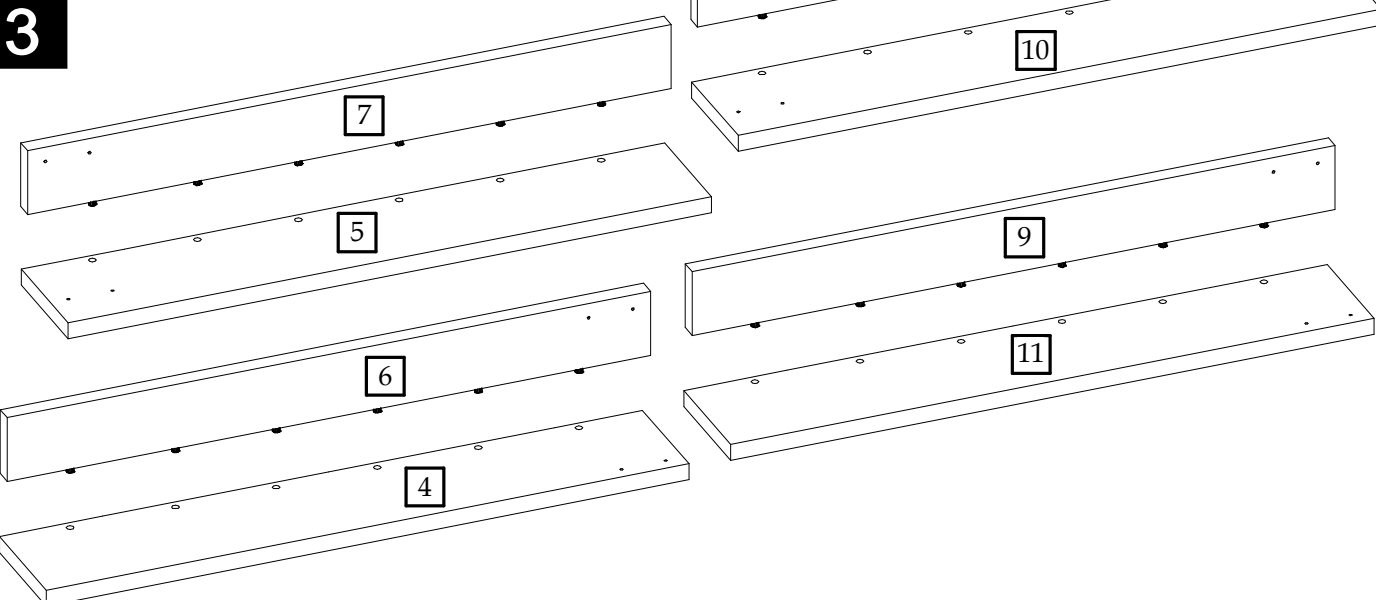

4

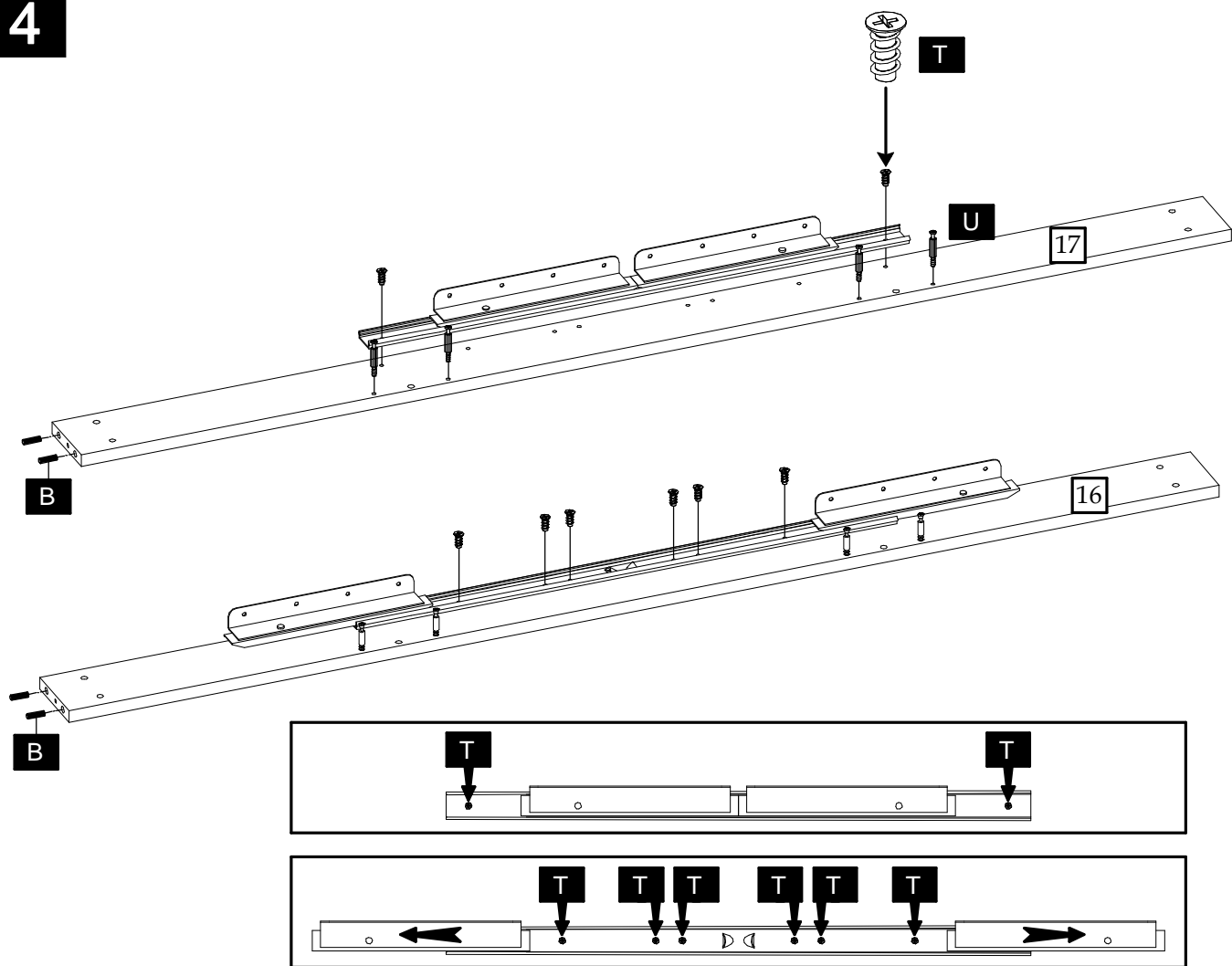

5

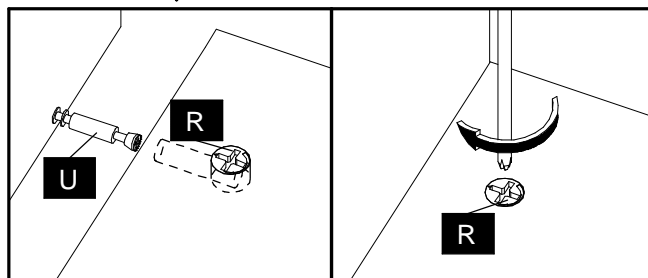
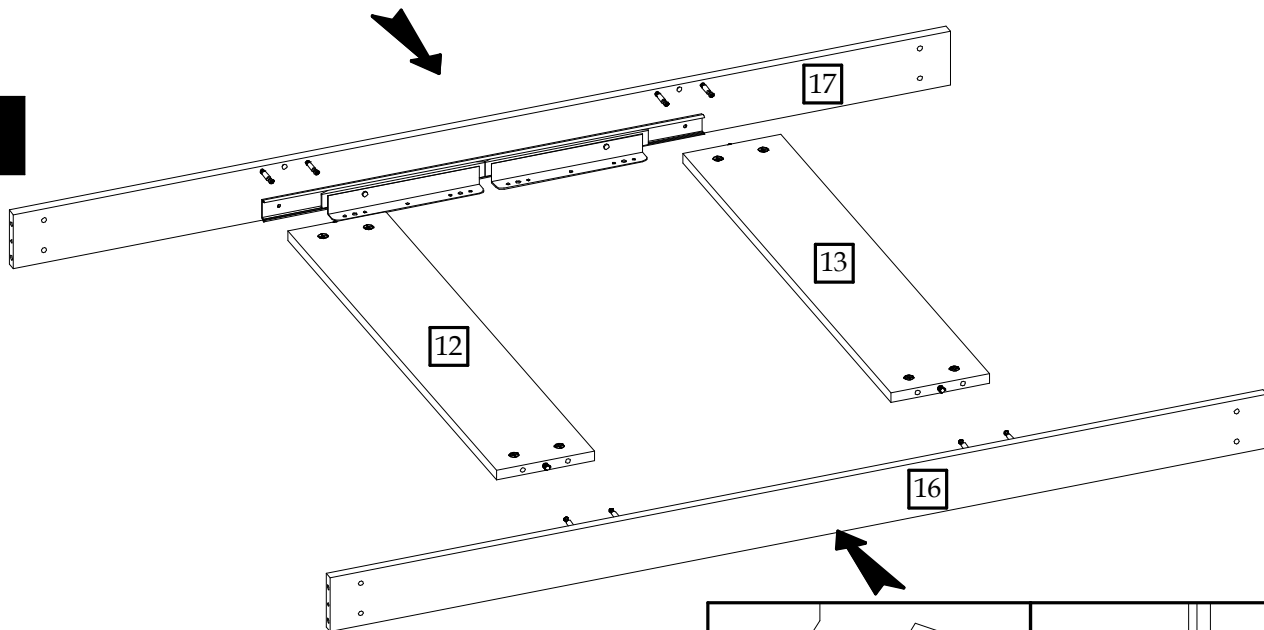

6

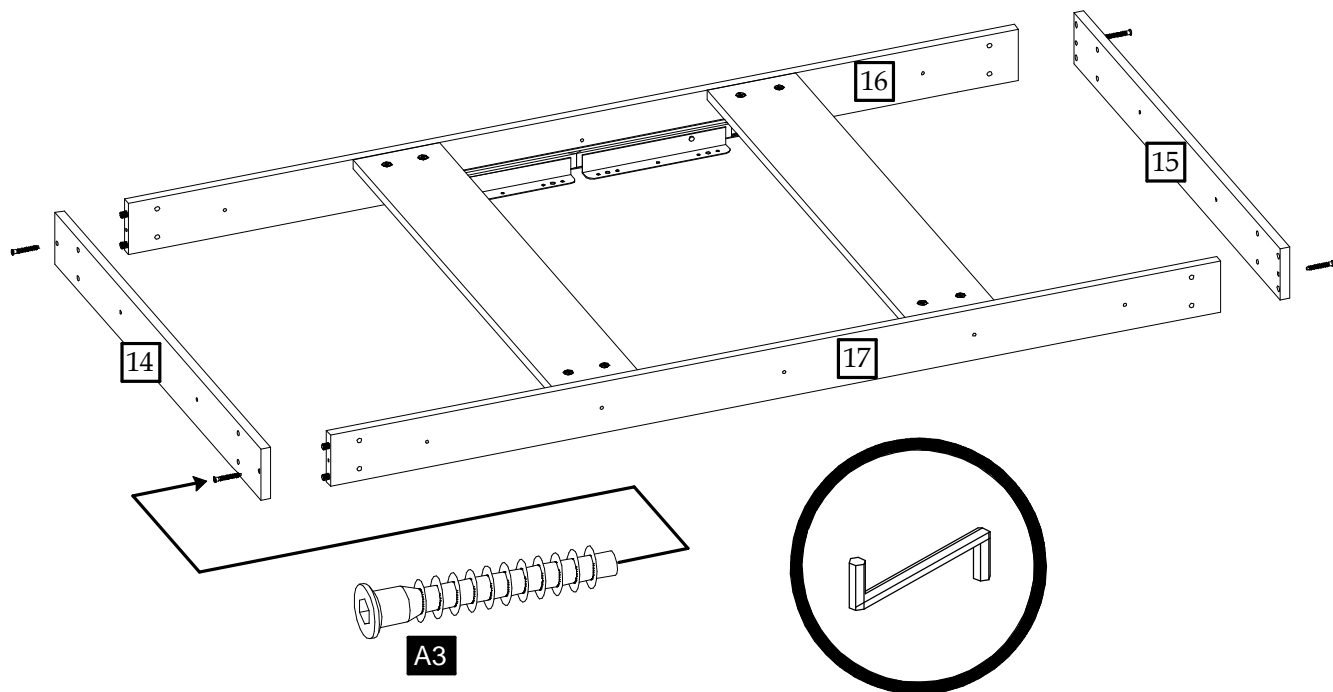

7

