

Moris/Mopric/Moppc

Showcase 1W1D
Witryna 1W1D
Витрина 1В1Д



number	Measurements	Pcs.
1	1964x375	1
2	1964x375	1
3	562x400	1
4	528x392	1
5	528x372	1
6	527x370	1
7	527x360	2
8	528x125	1
9	1964x80	1
10	1964x80	1

11	1051x396	1
12	396x696	1
13	1902x547	1

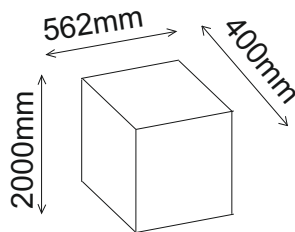
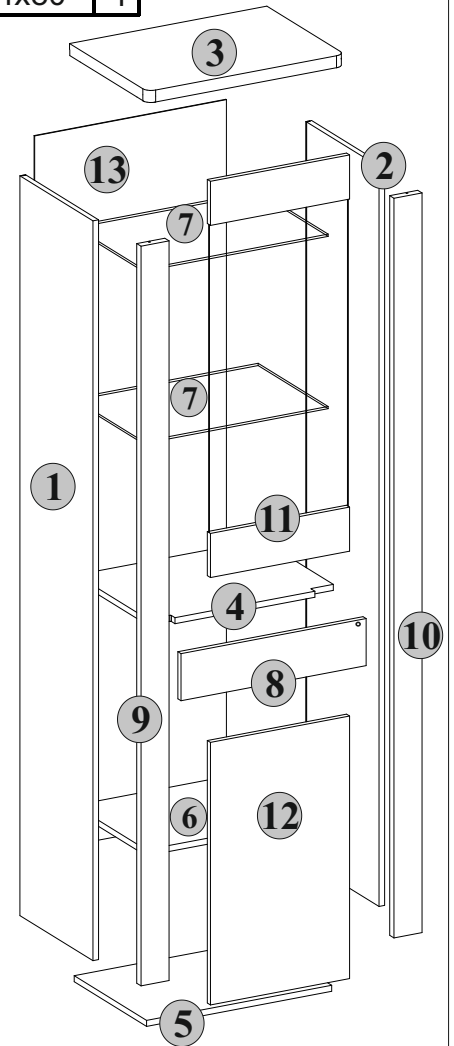
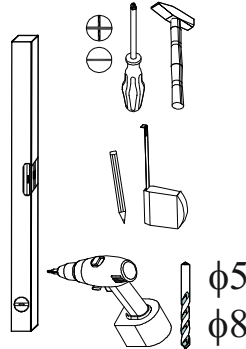
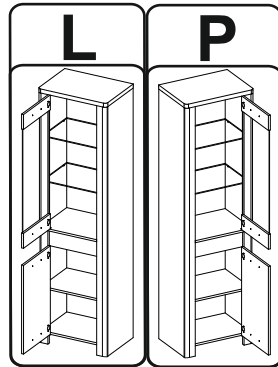
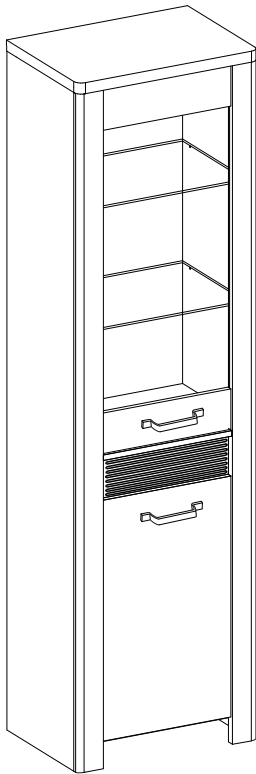

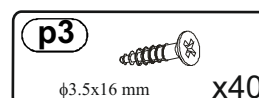
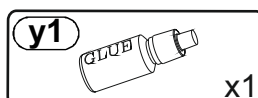
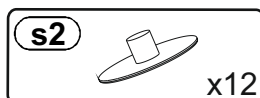
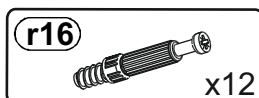
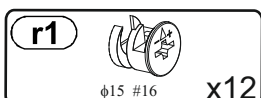
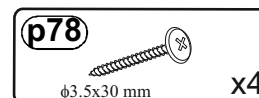
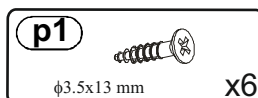
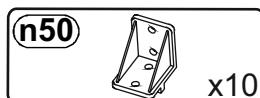
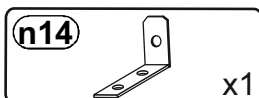
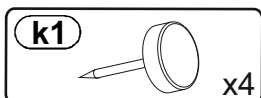
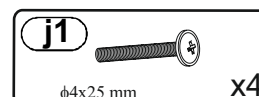
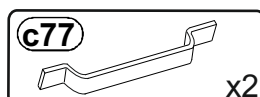
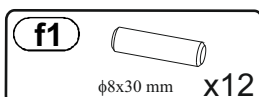
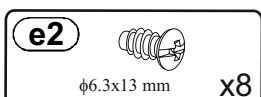
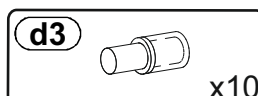
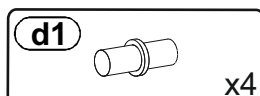
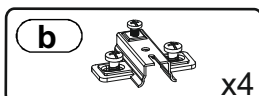
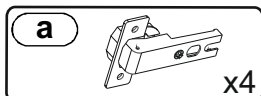
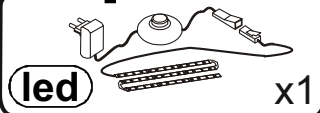

Option

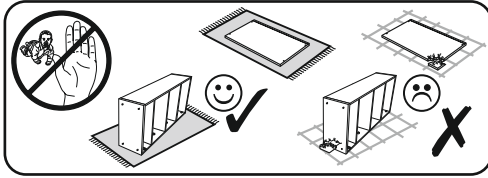

I

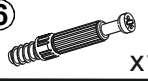

- r1**  $\phi 15 \#16$ x4
- r16**  x12
- f1**  $\phi 8 \times 30$ mm x4

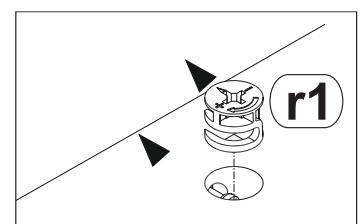
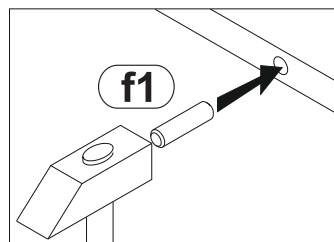
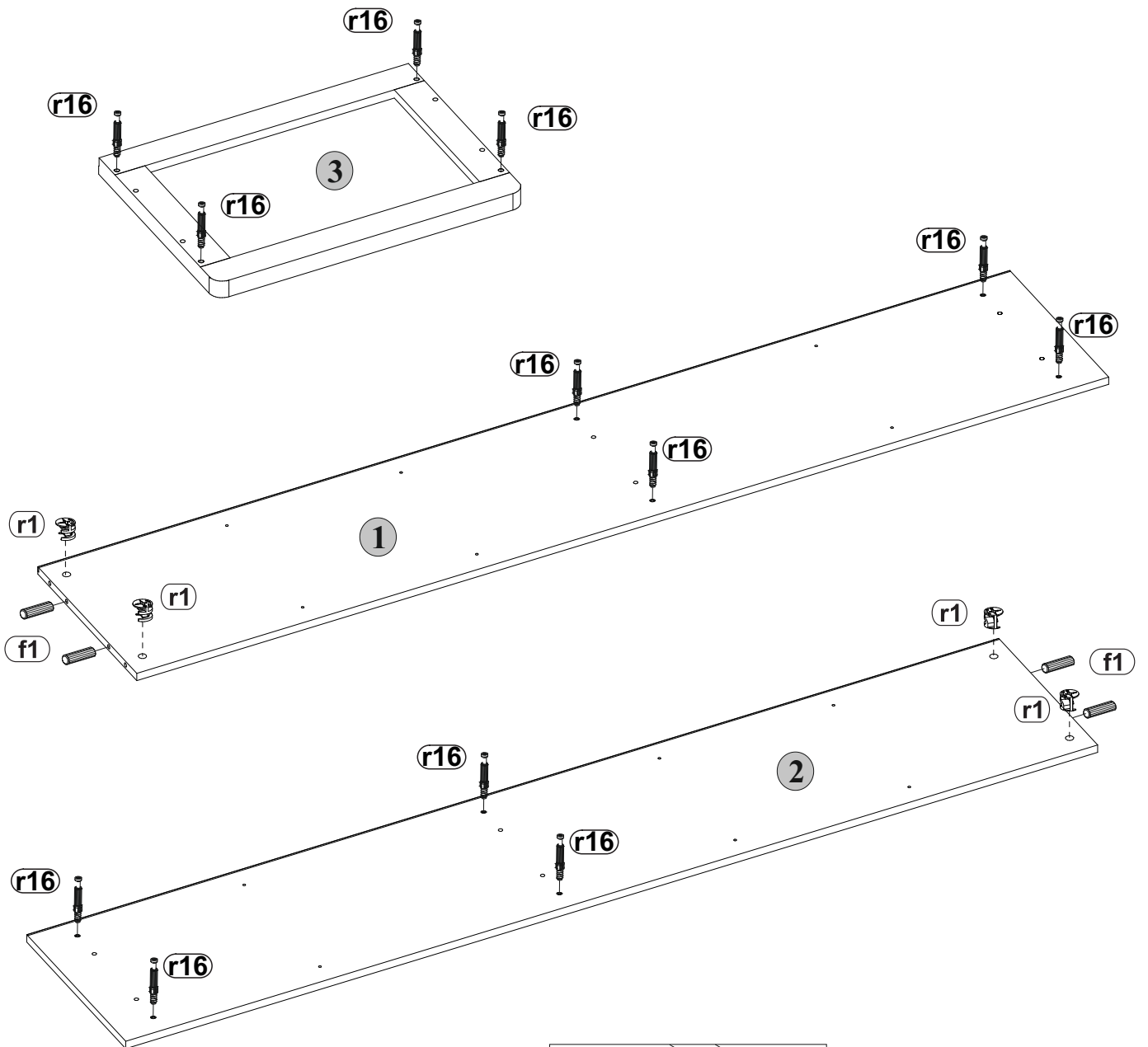
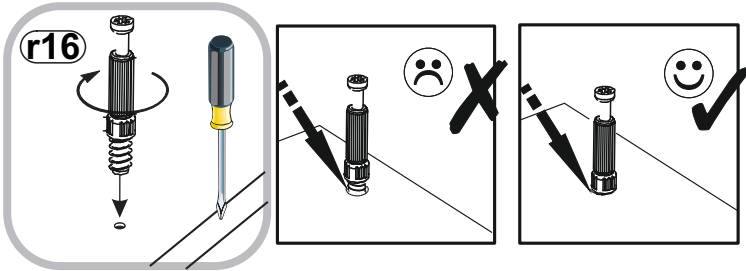

2

2

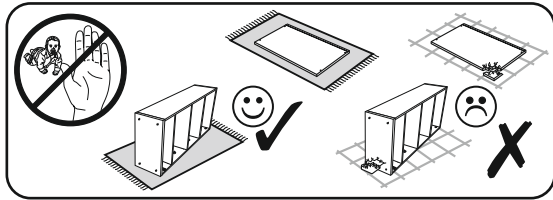

- r1** $\phi 15 \#16$ x8
- f1** $\phi 8 \times 30$ mm x8

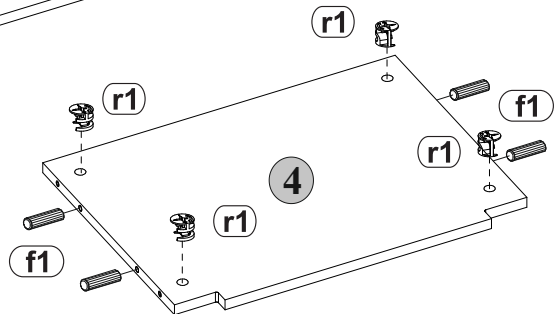
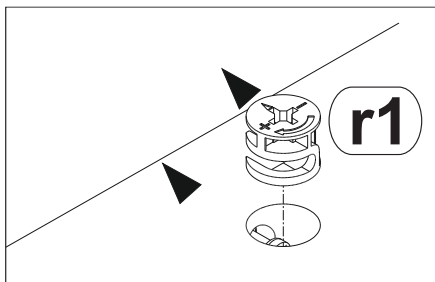
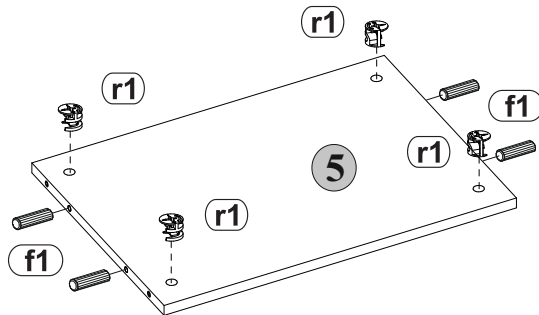
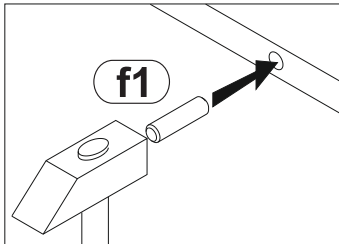

3 P

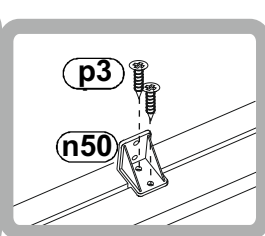
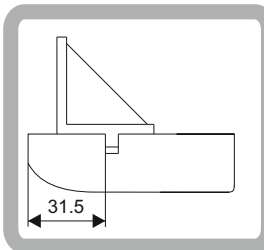
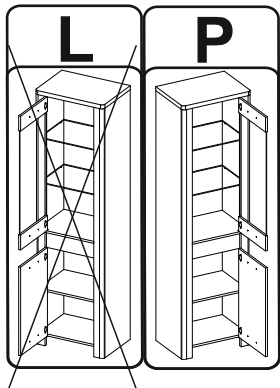

- b** x4
- n50** x10
- e2** $\phi 6.3 \times 13$ mm x8
- p3** $\phi 3.5 \times 16$ mm x20

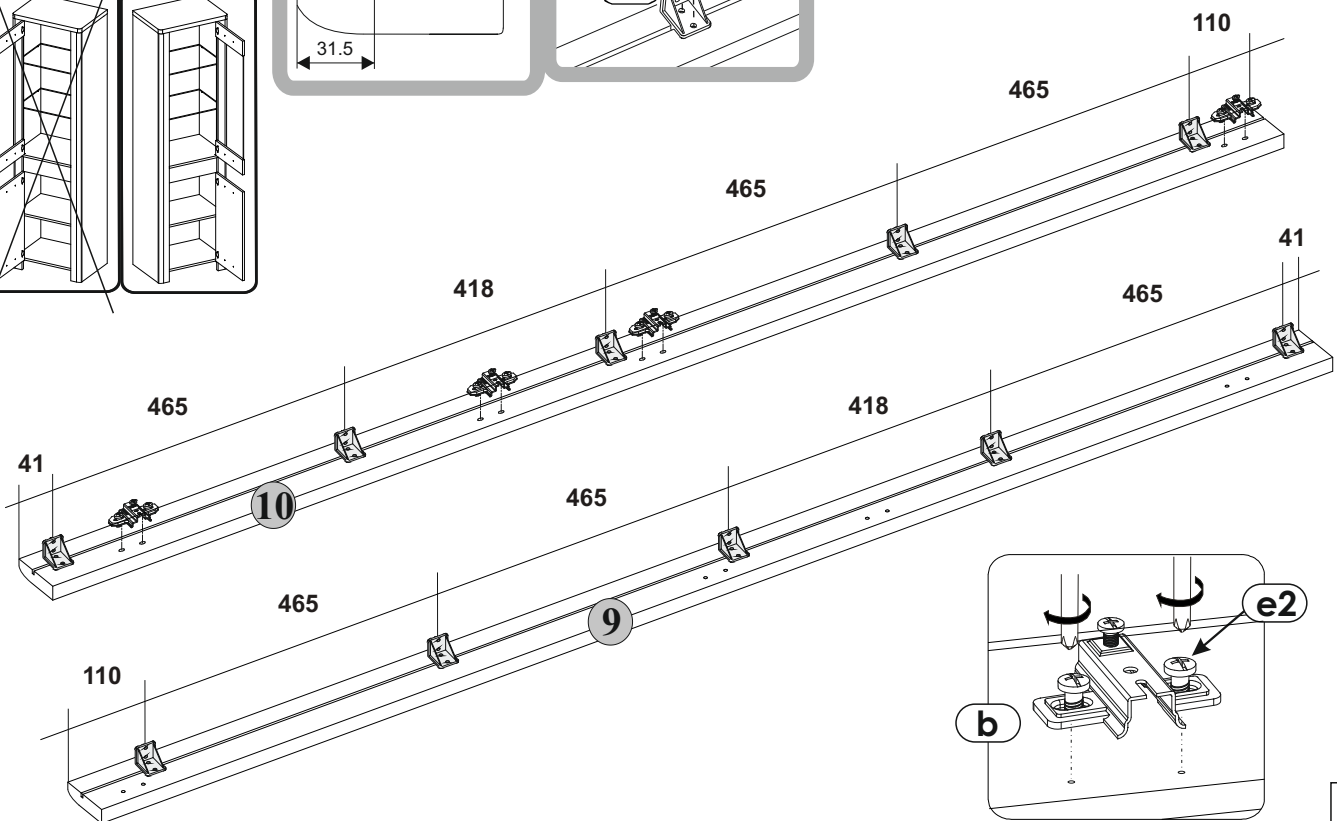

3

3 L

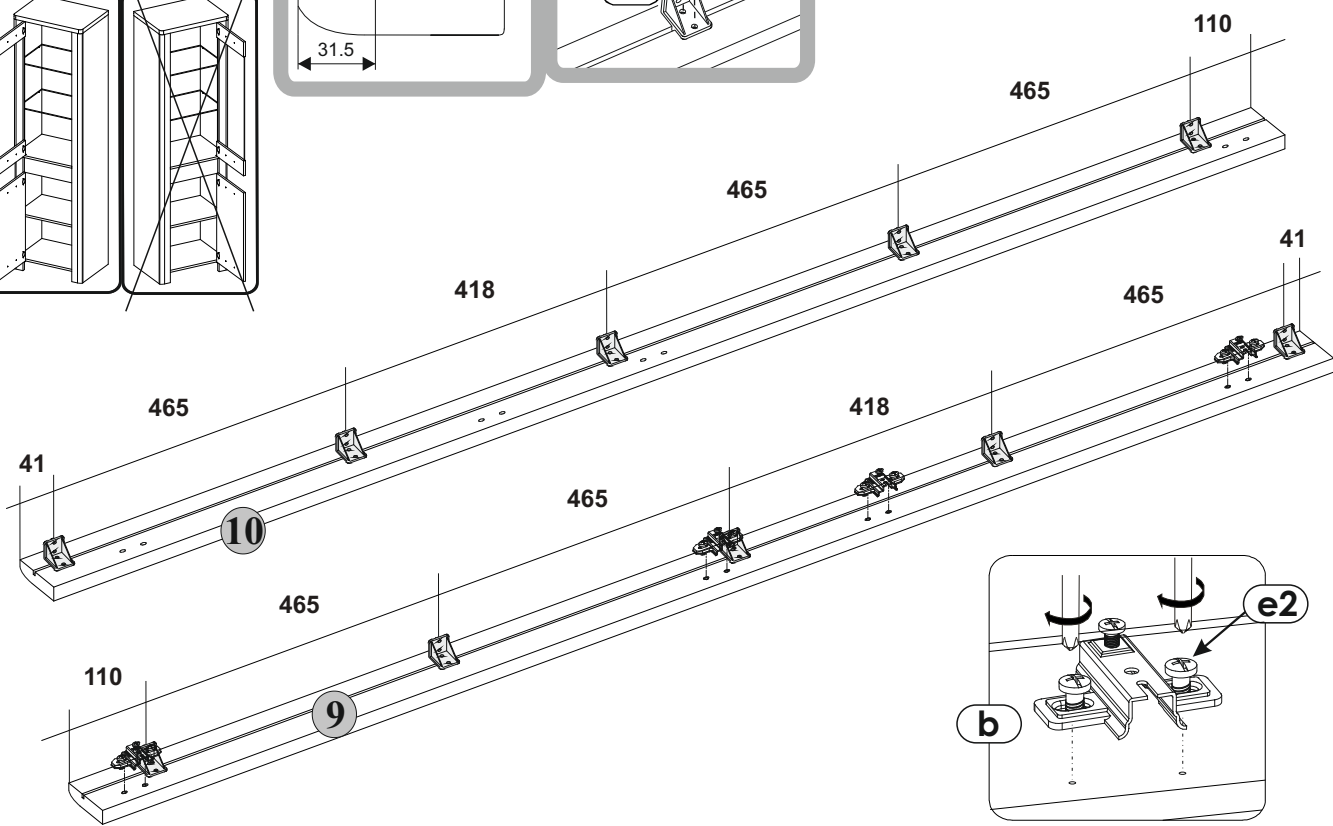
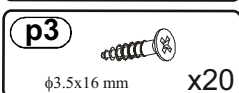
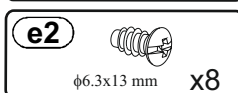
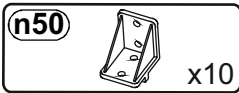
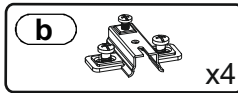
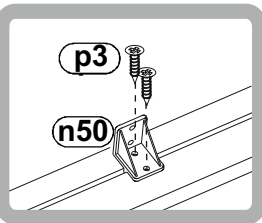
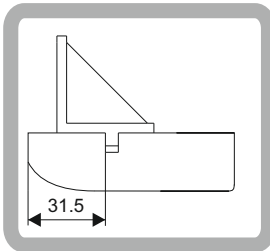
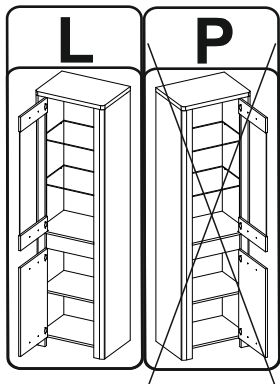

4

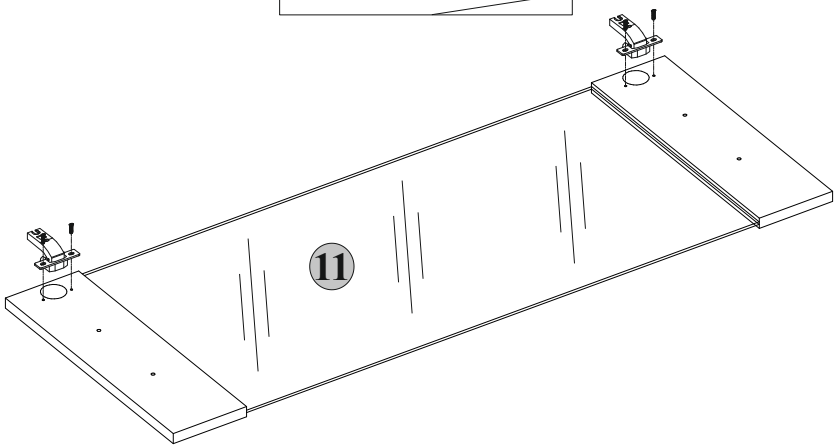
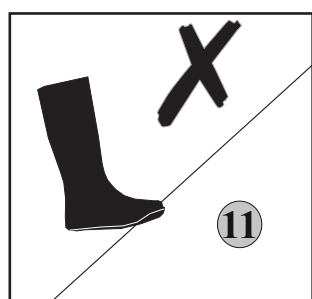
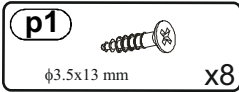
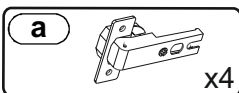
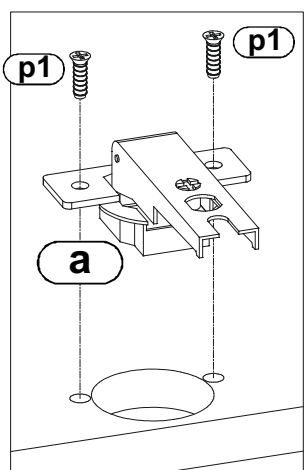
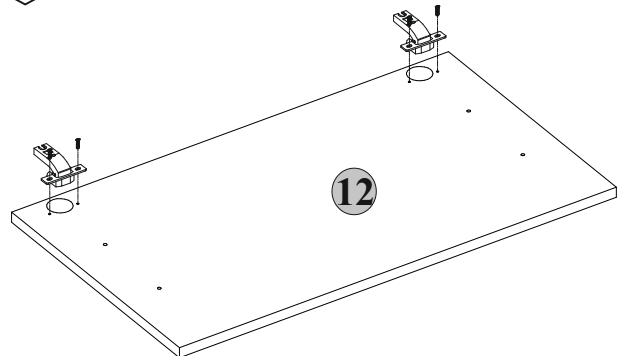

4

5

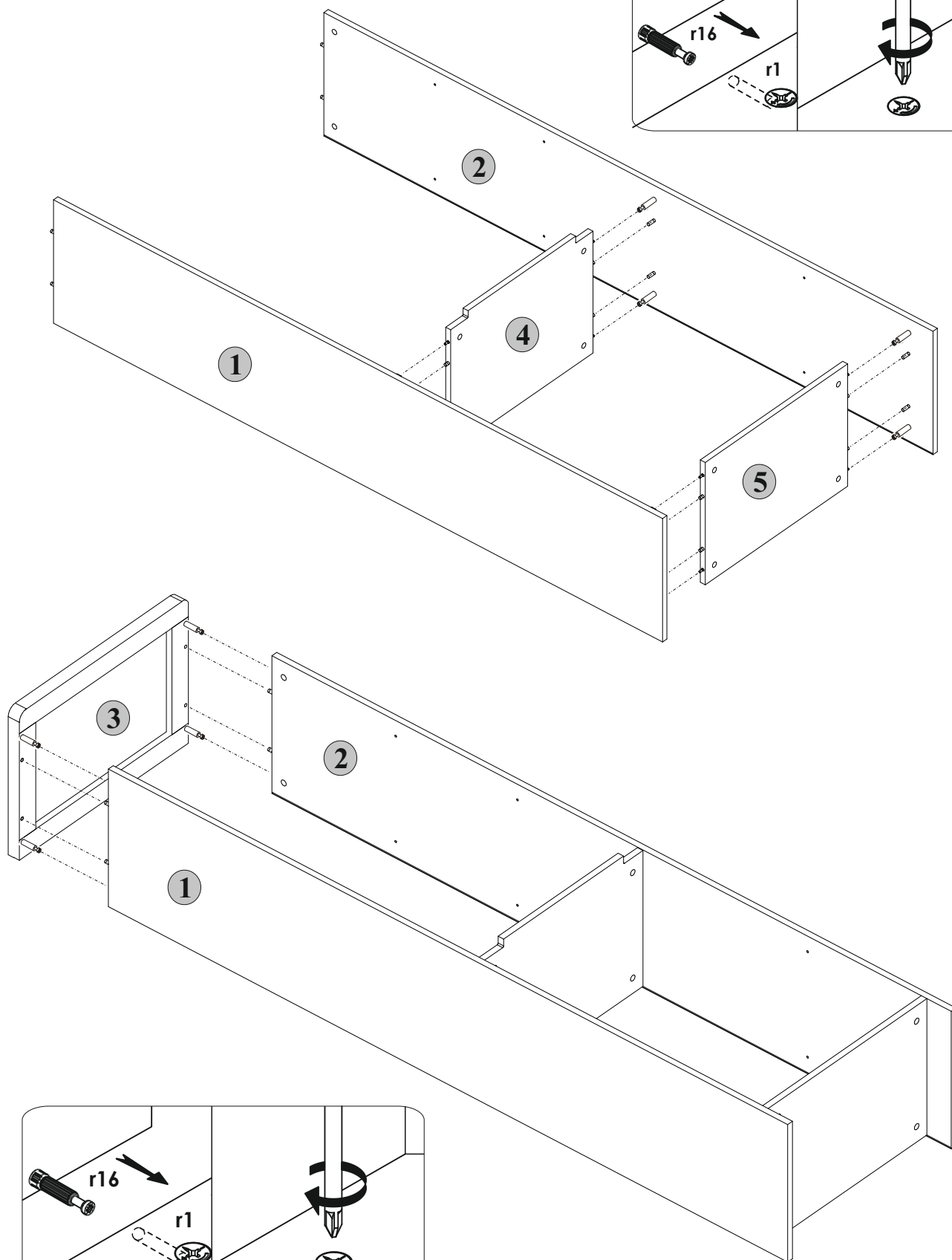
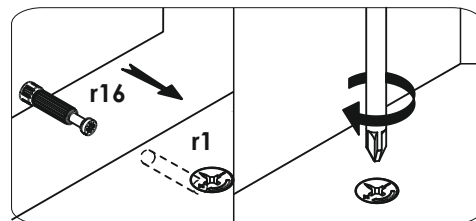
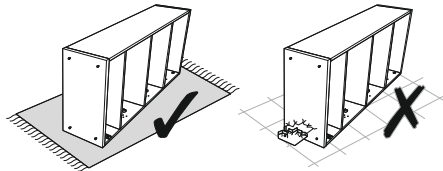

5

6

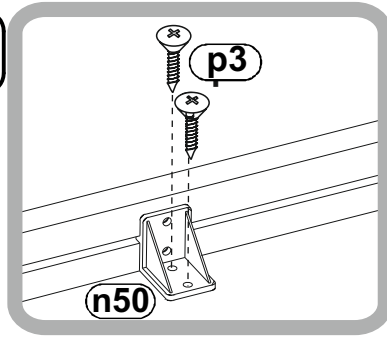

p3
φ3.5x16 mm x20

p78
φ3.5x30 mm x4

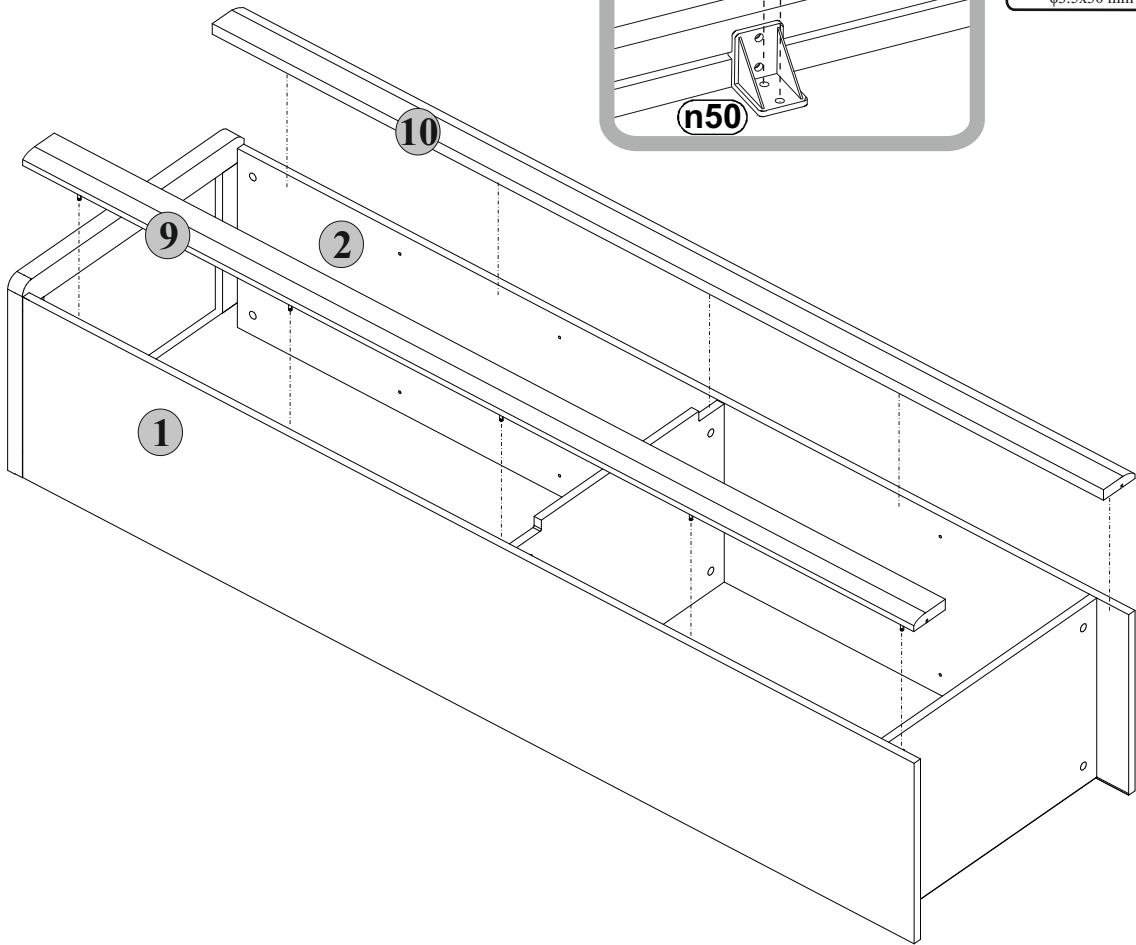

7

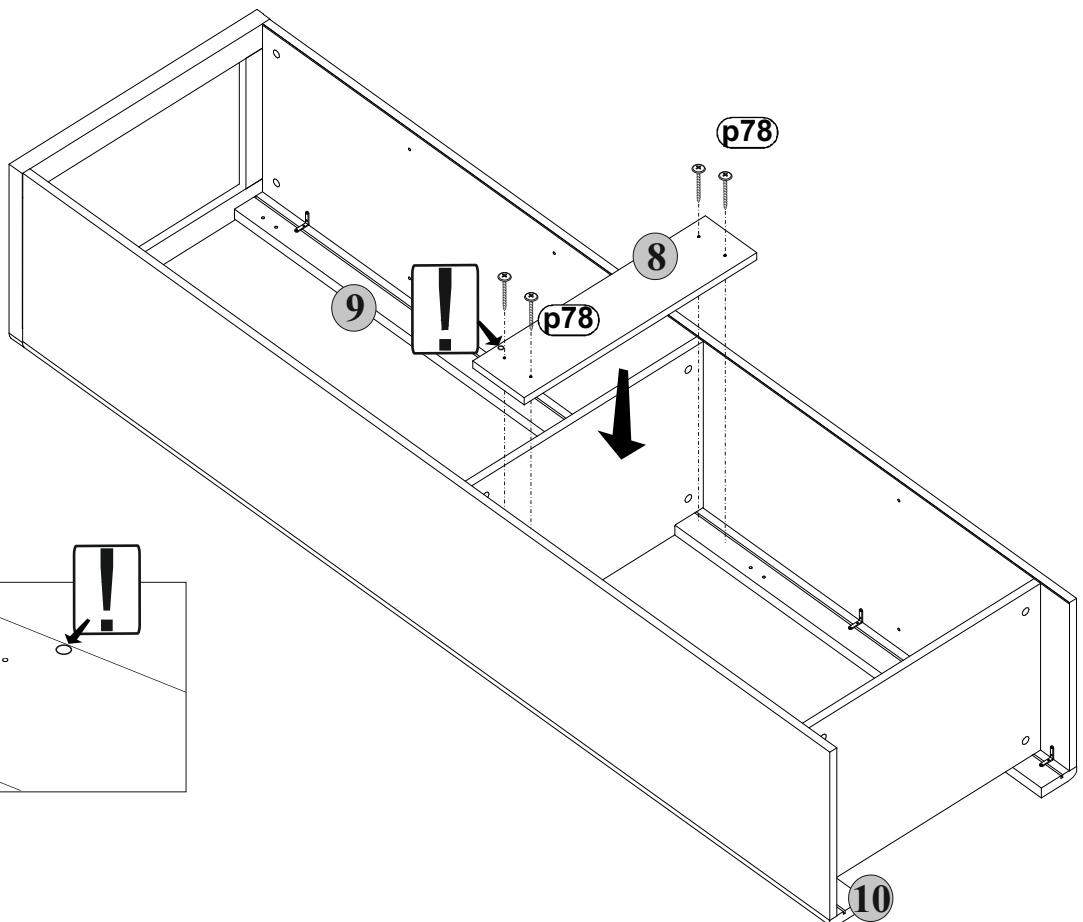

6

8

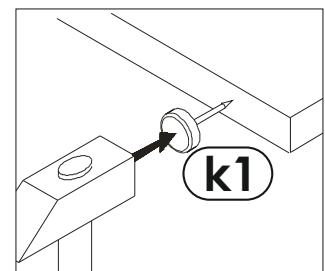
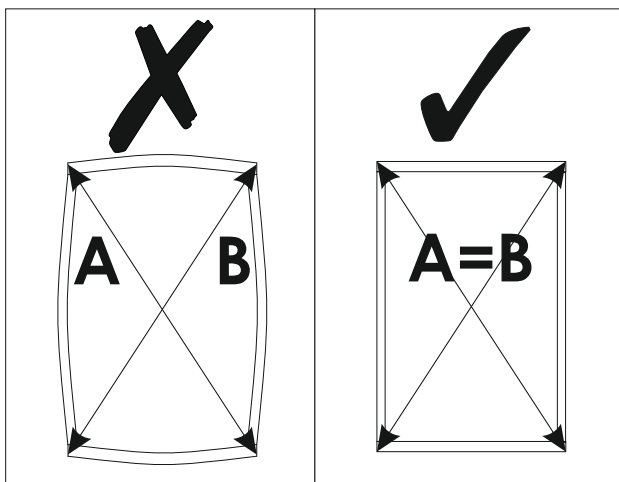
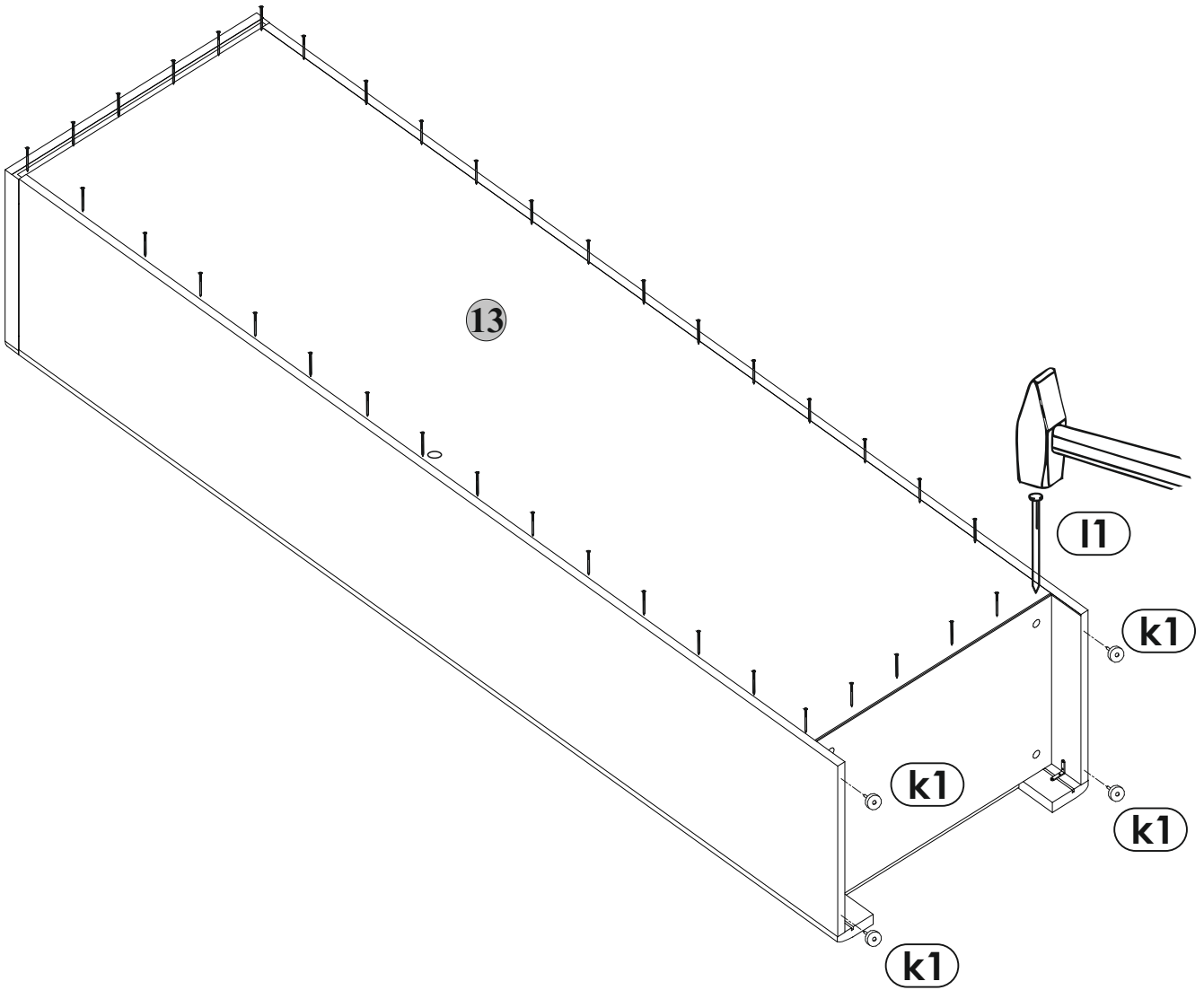
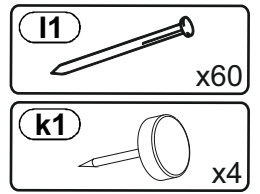



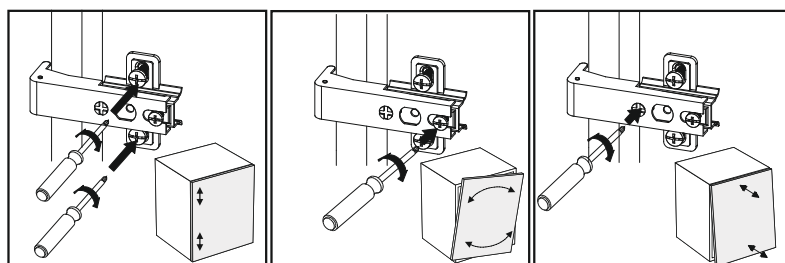
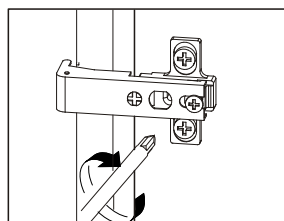
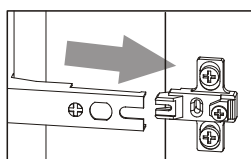
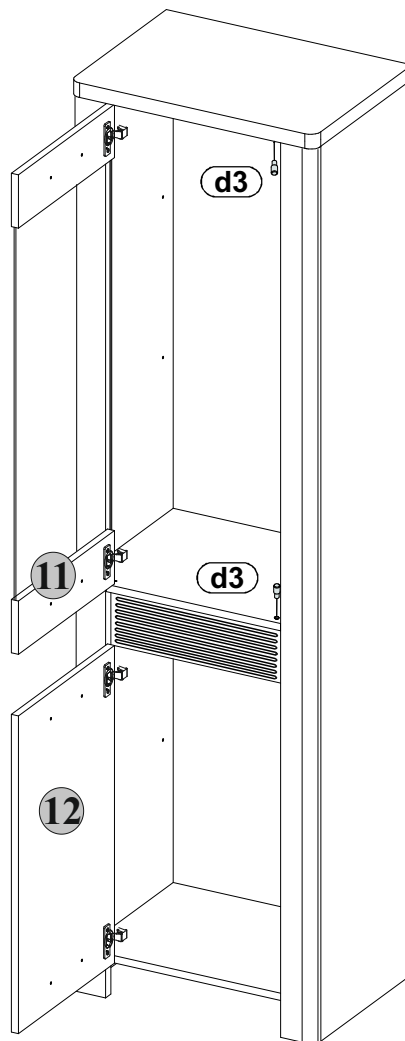
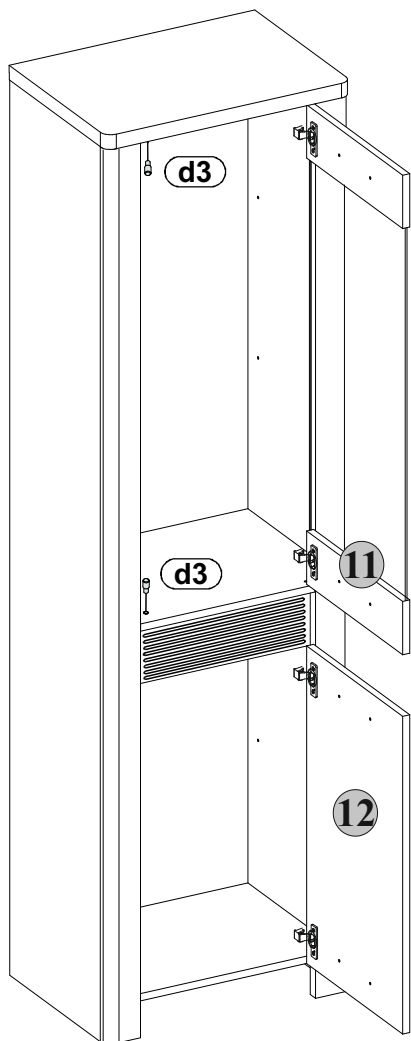
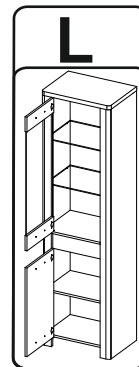
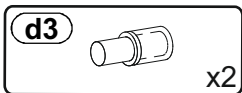
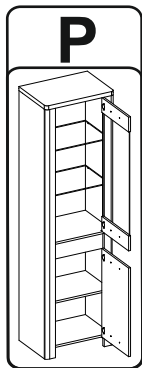

9



8

10

- c77**  x2
- j1**  $\phi 4 \times 25$ mm x4
- d3**  x8
- d1**  x4
- s2**  x18

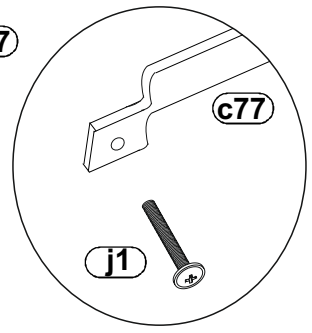
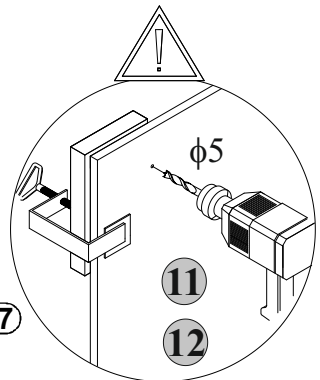
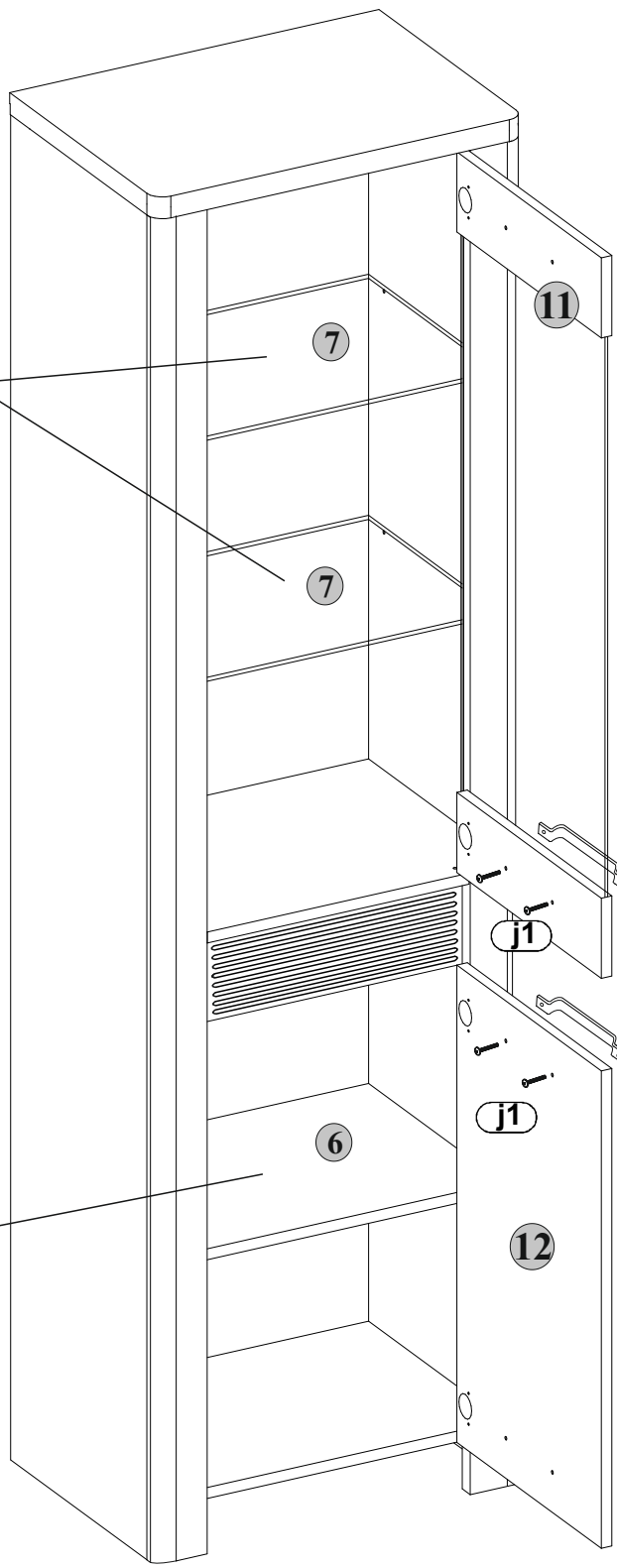
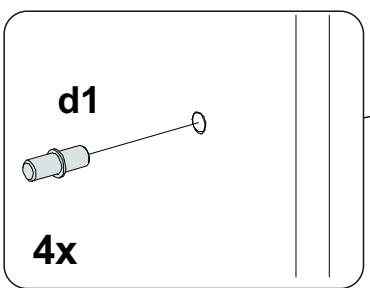
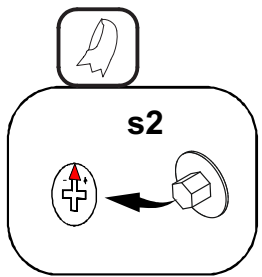
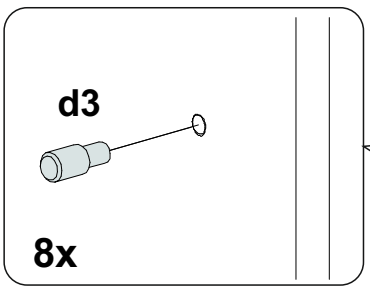

11

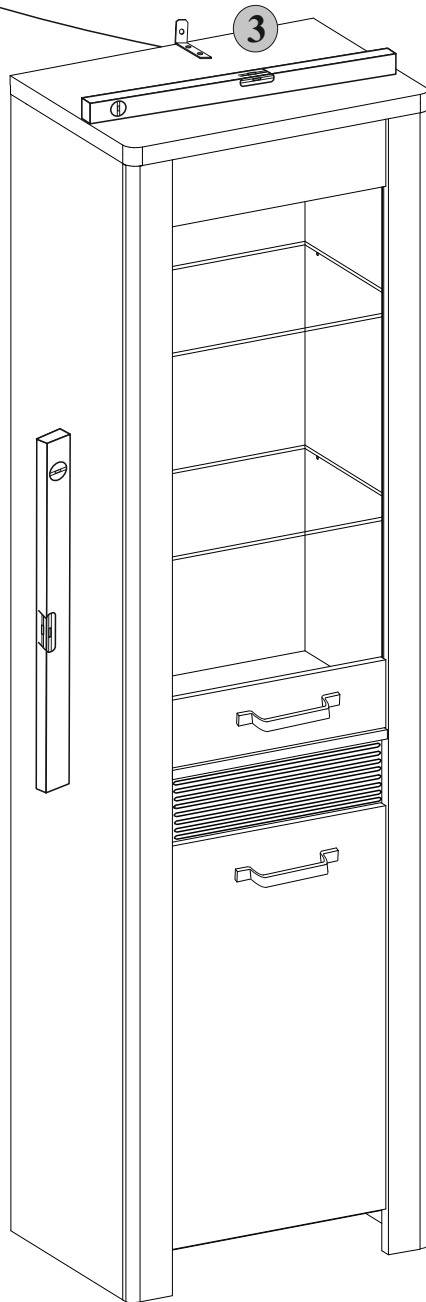
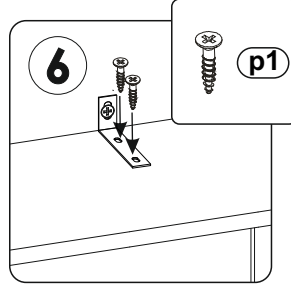
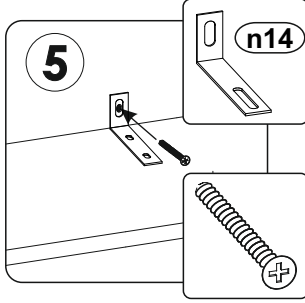
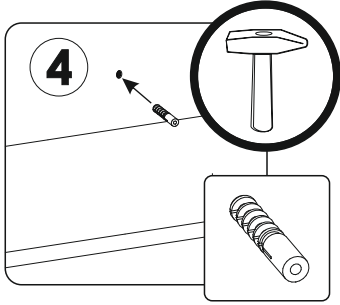
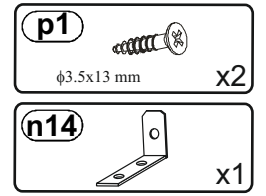
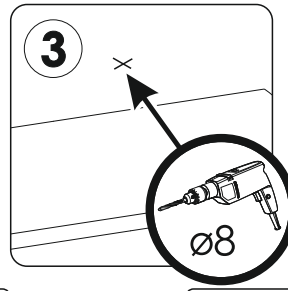
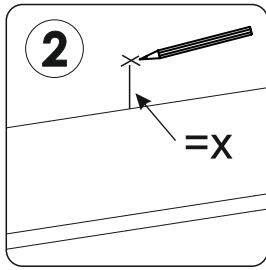
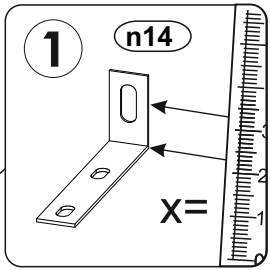

OPTION

Option

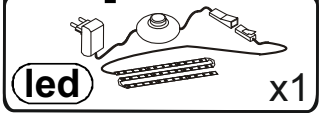

led x1

