

Adam

Typ S

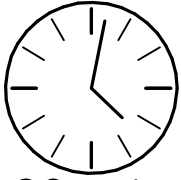

90 min

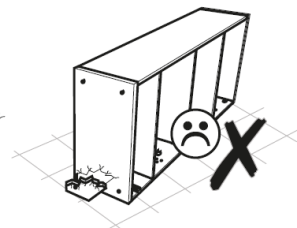
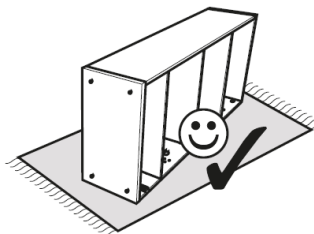
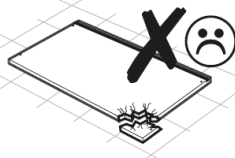
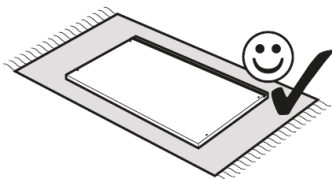
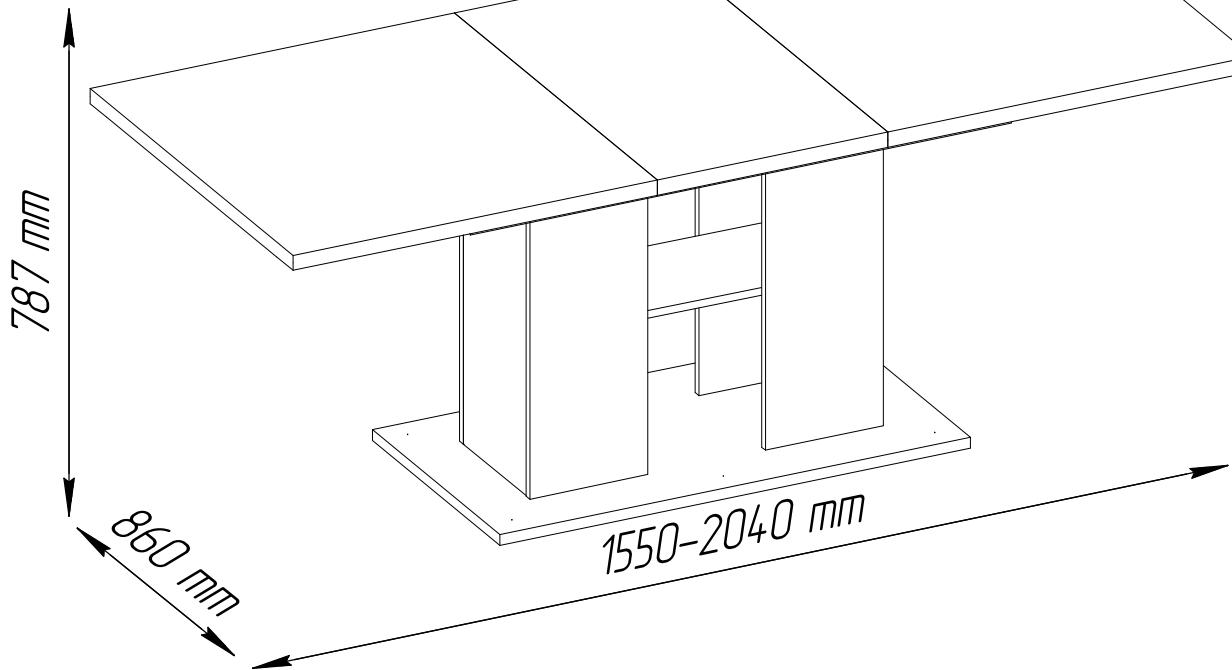
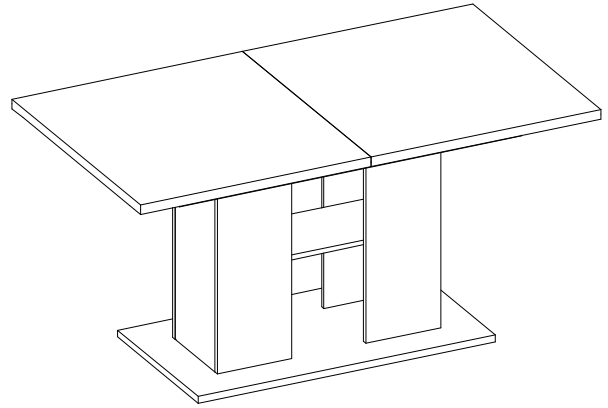
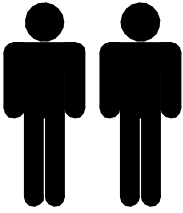

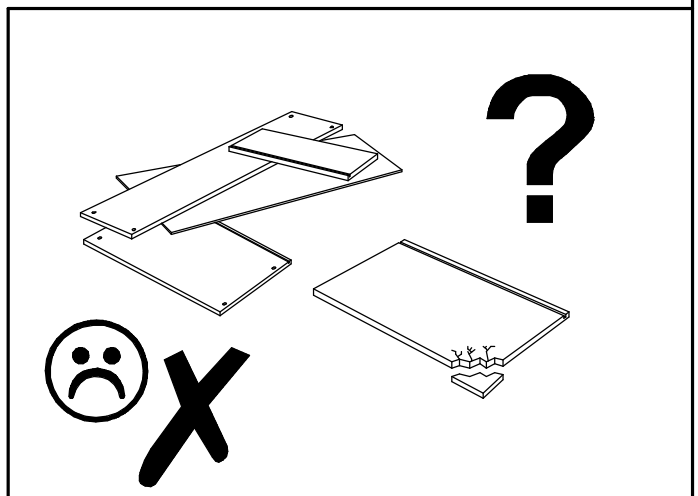
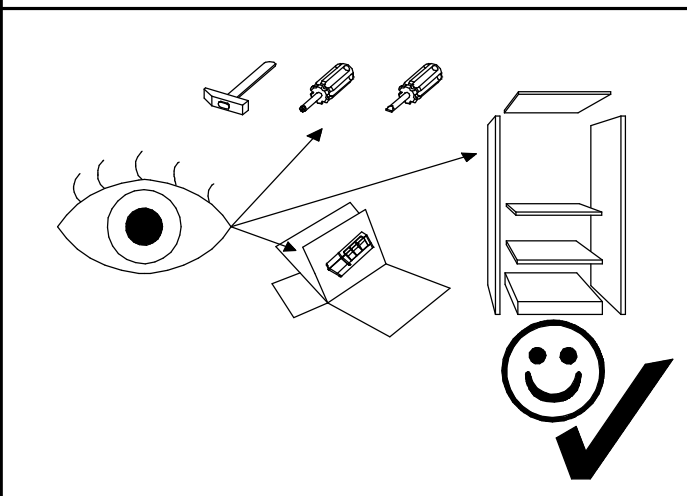
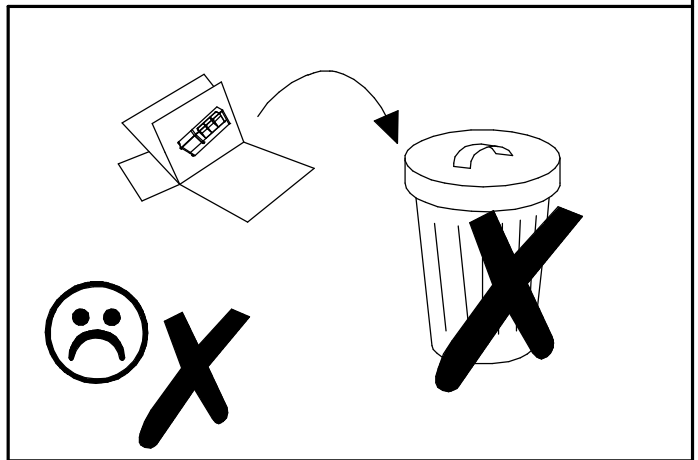
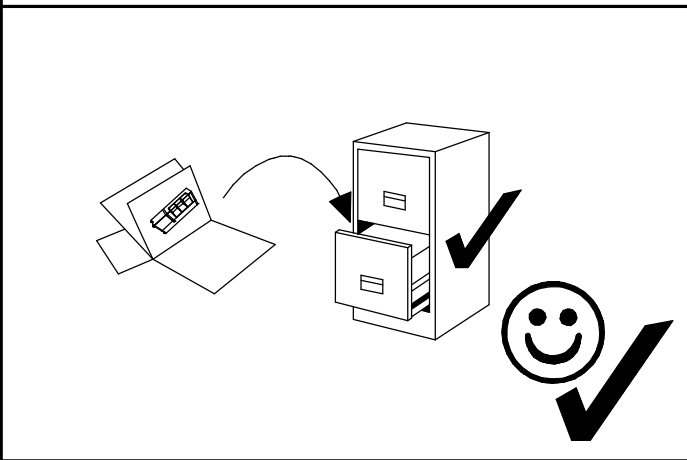
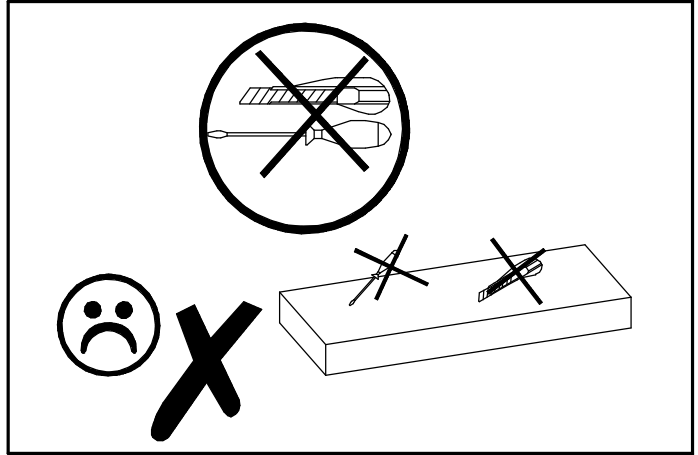
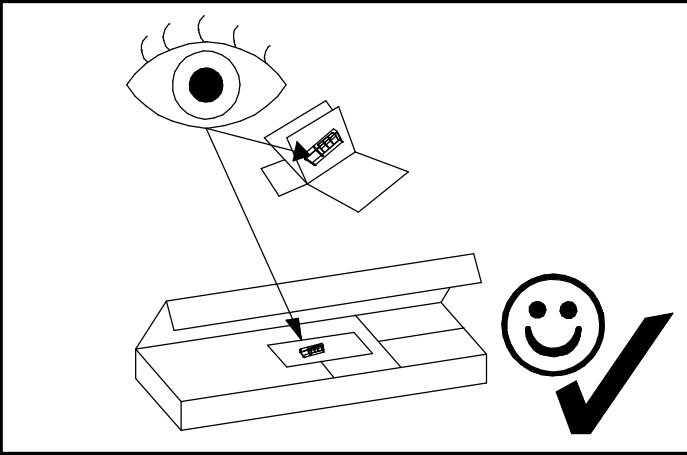

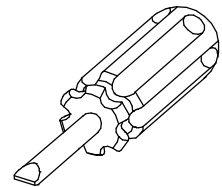
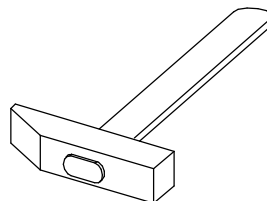
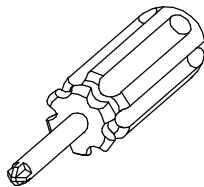
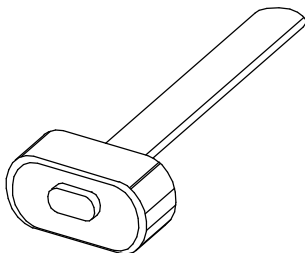
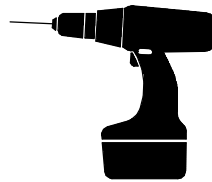
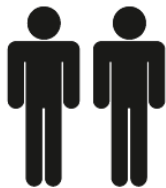
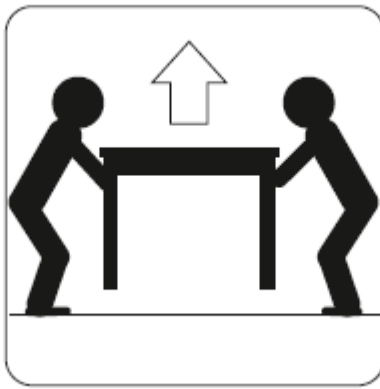
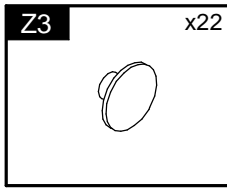
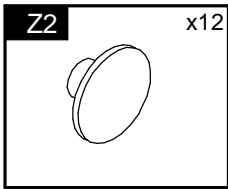
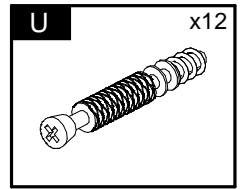
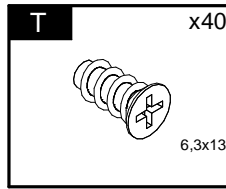
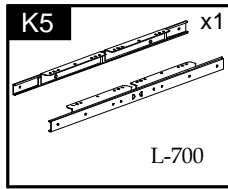
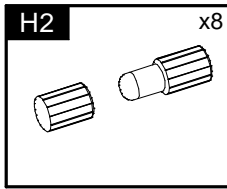
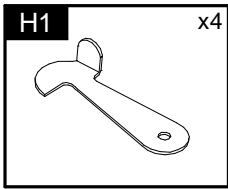
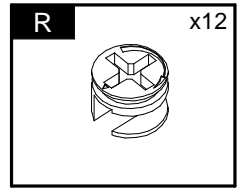
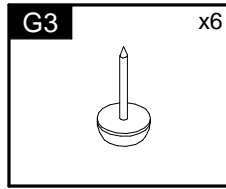
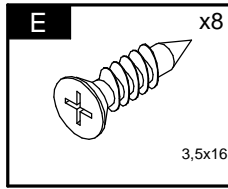
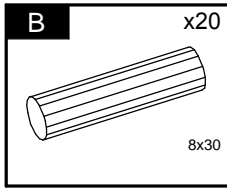
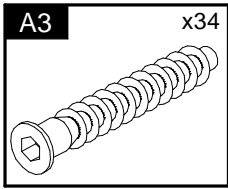
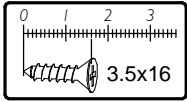
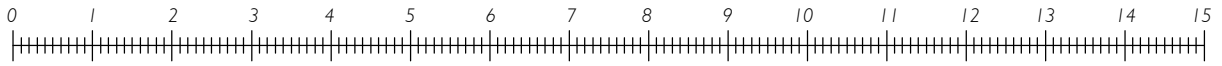

Element symbol	Measurements				Code	Paket
1	860	775	32	1	1040/2040	1/2
2	860	775	32	1	1041/2041	1/2
3	860	490	32	1	1042/2042	1/2
4	540	1000	22	1	1002	2/2
5	266	718	16	1	1030	2/2
6	266	652	16	1	1031	1/2
7	266	652	16	1	1032	1/2
8	652	251	16	1	1017	1/2
9	652	251	16	1	1018	1/2
10	652	251	16	1	1022	1/2
11	652	251	16	1	1023	1/2
12	1150	592	16	1	1035	2/2
13	1148	70	16	1	1033	2/2
14	1148	70	16	1	1034	2/2

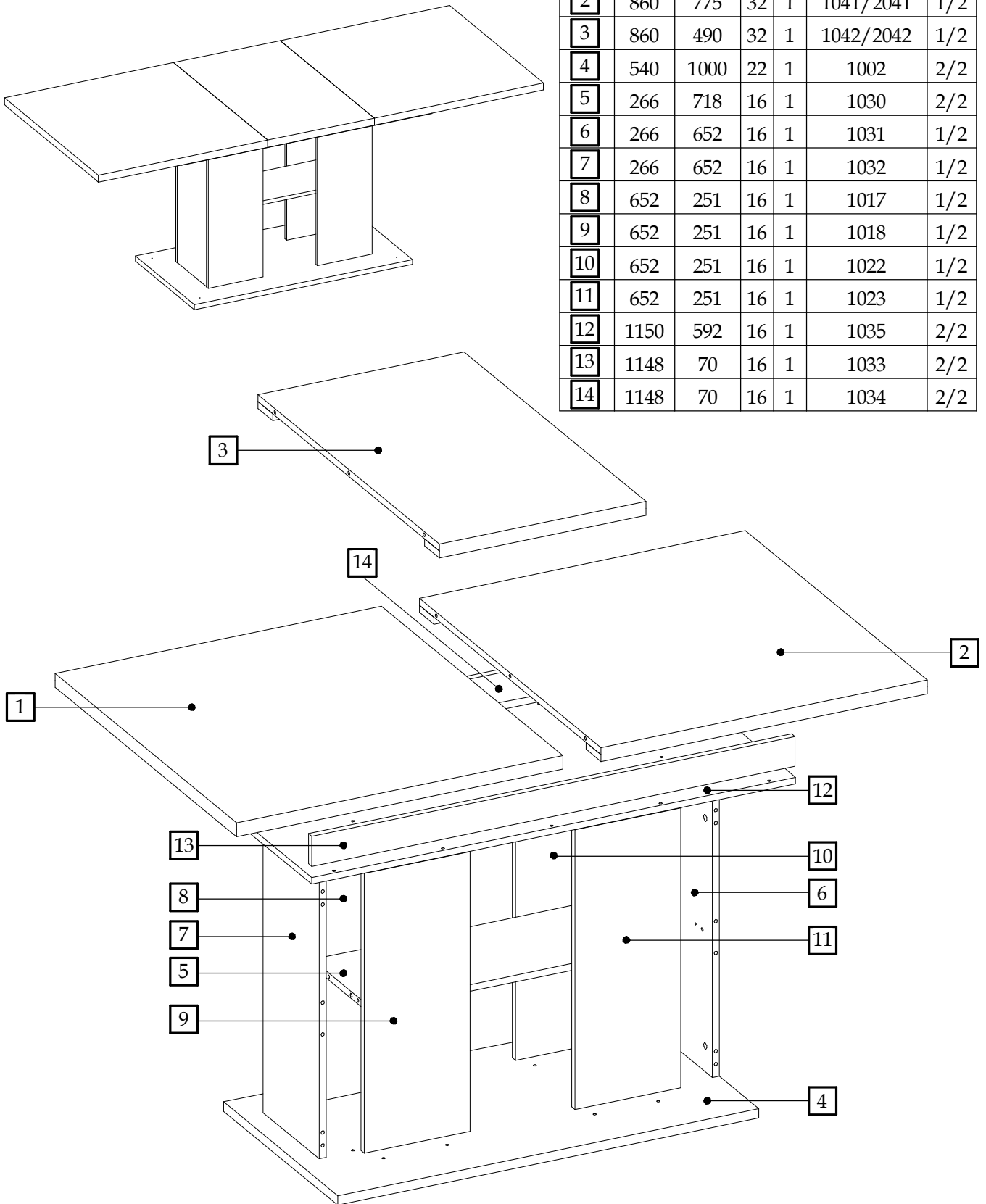

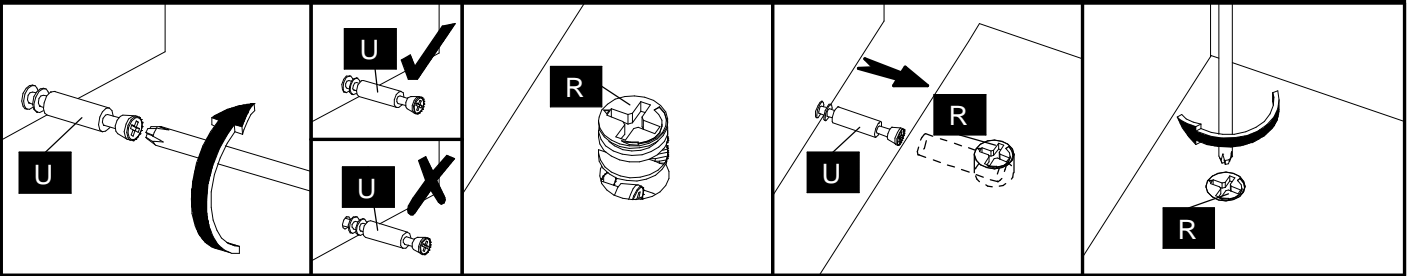

1

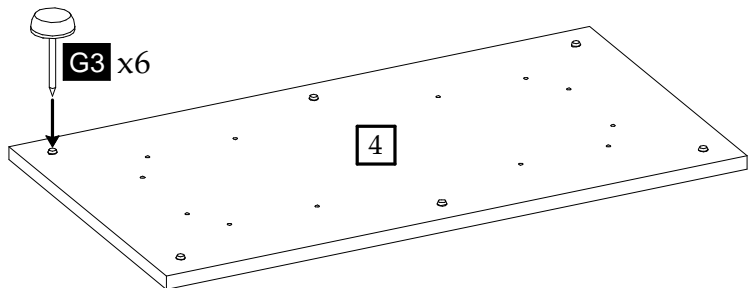
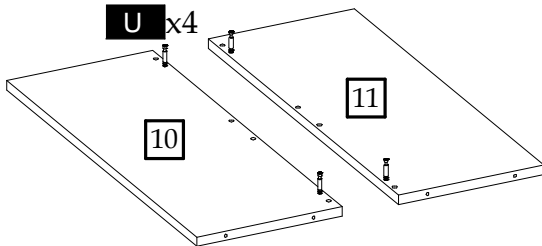
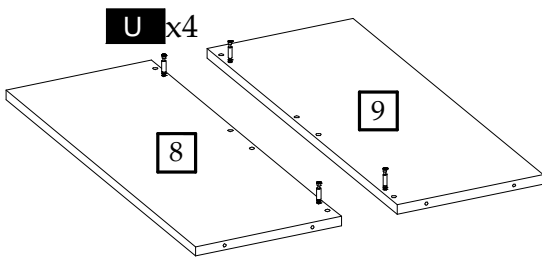
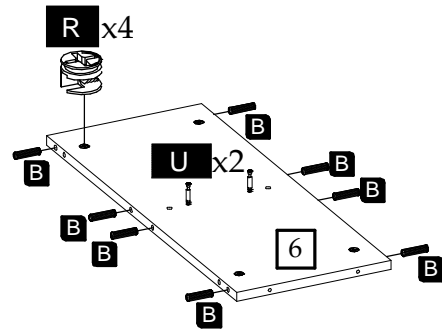
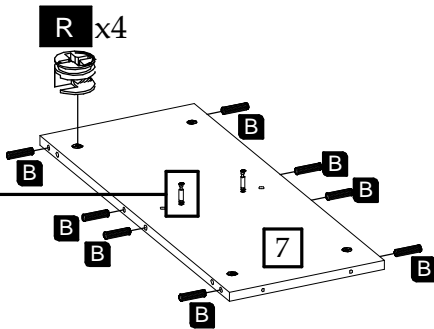
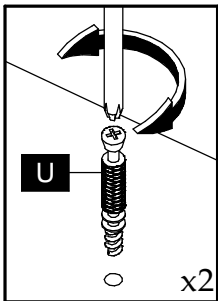
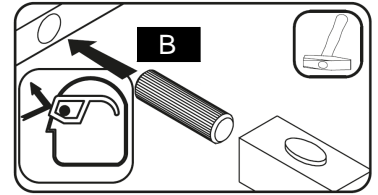
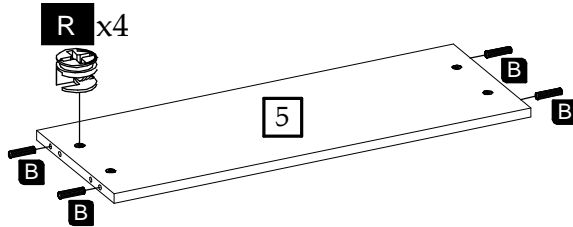
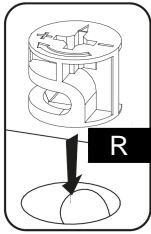

2

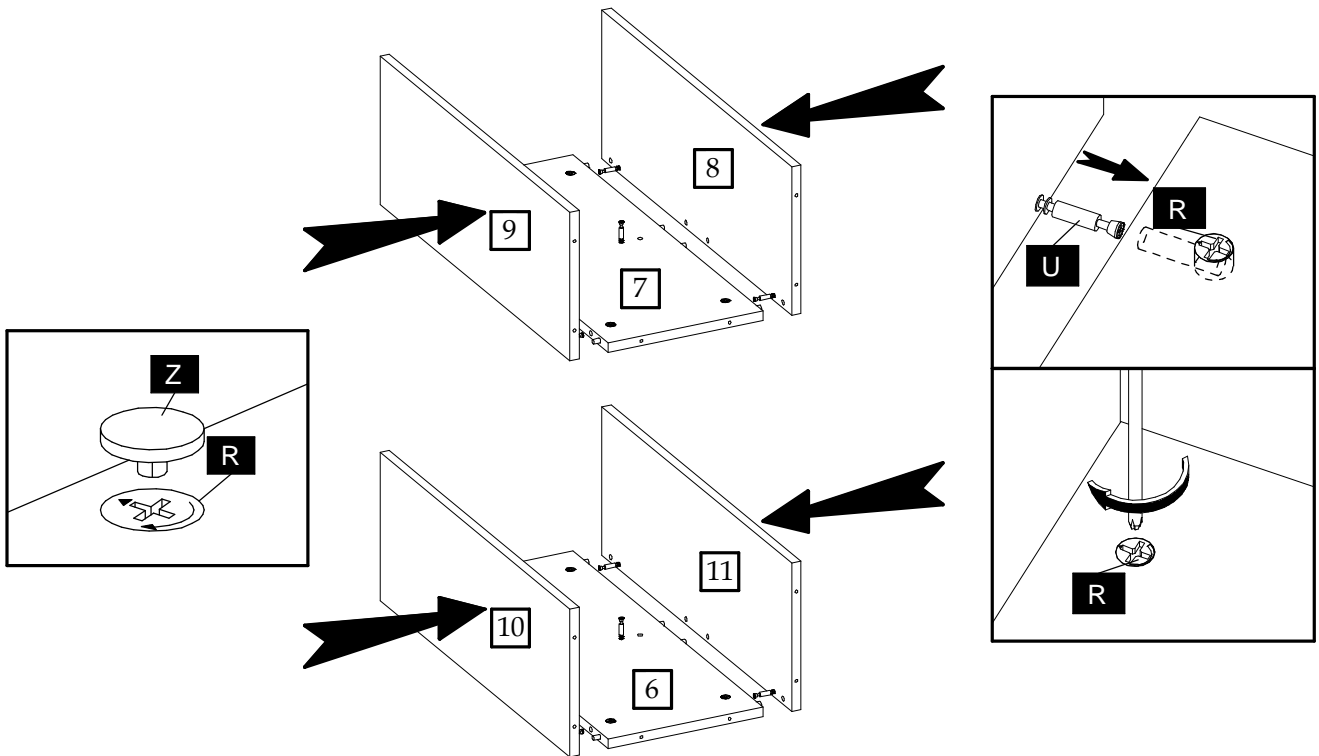

3

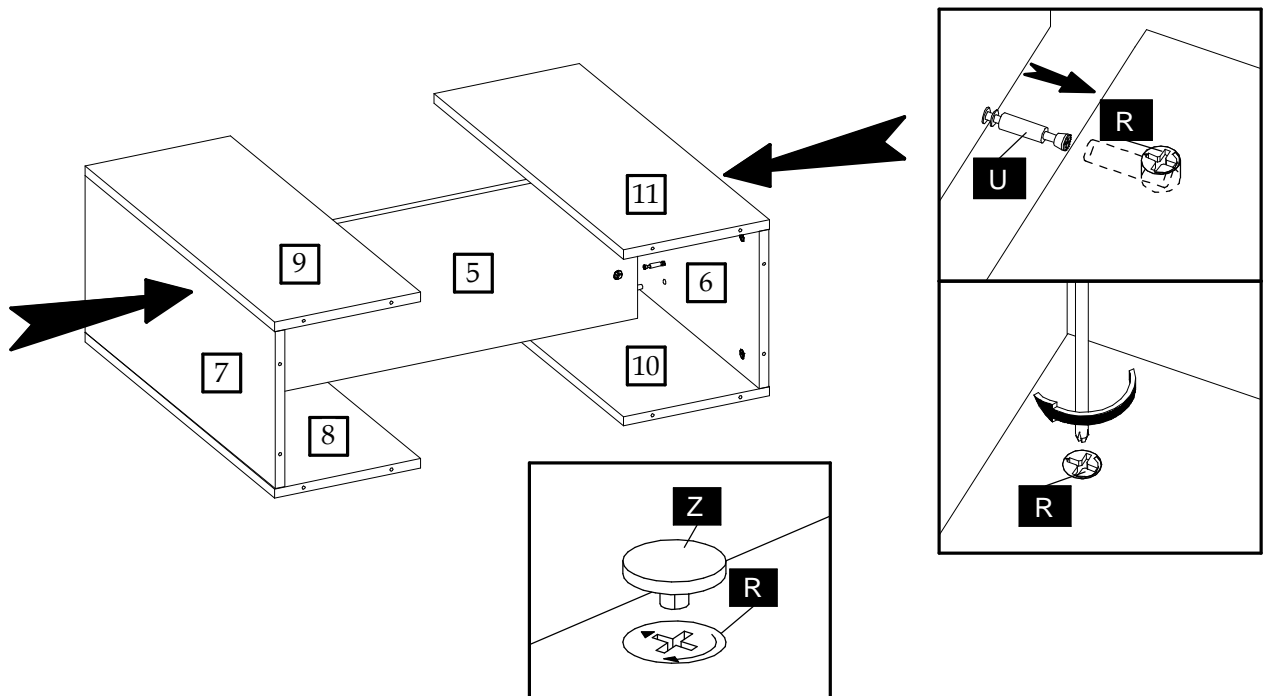

4

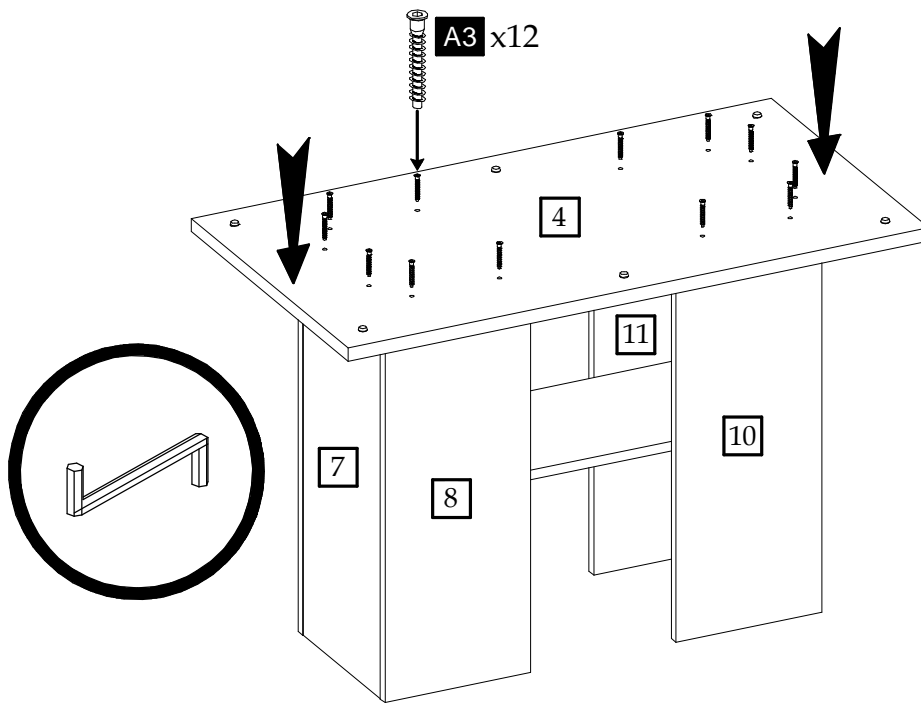

5

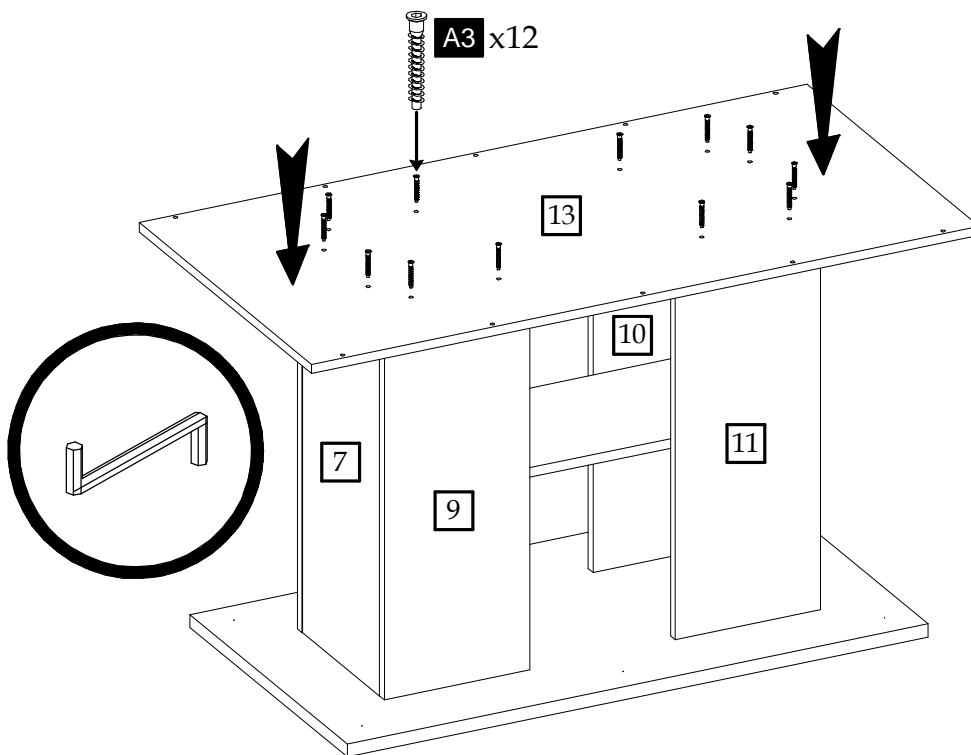

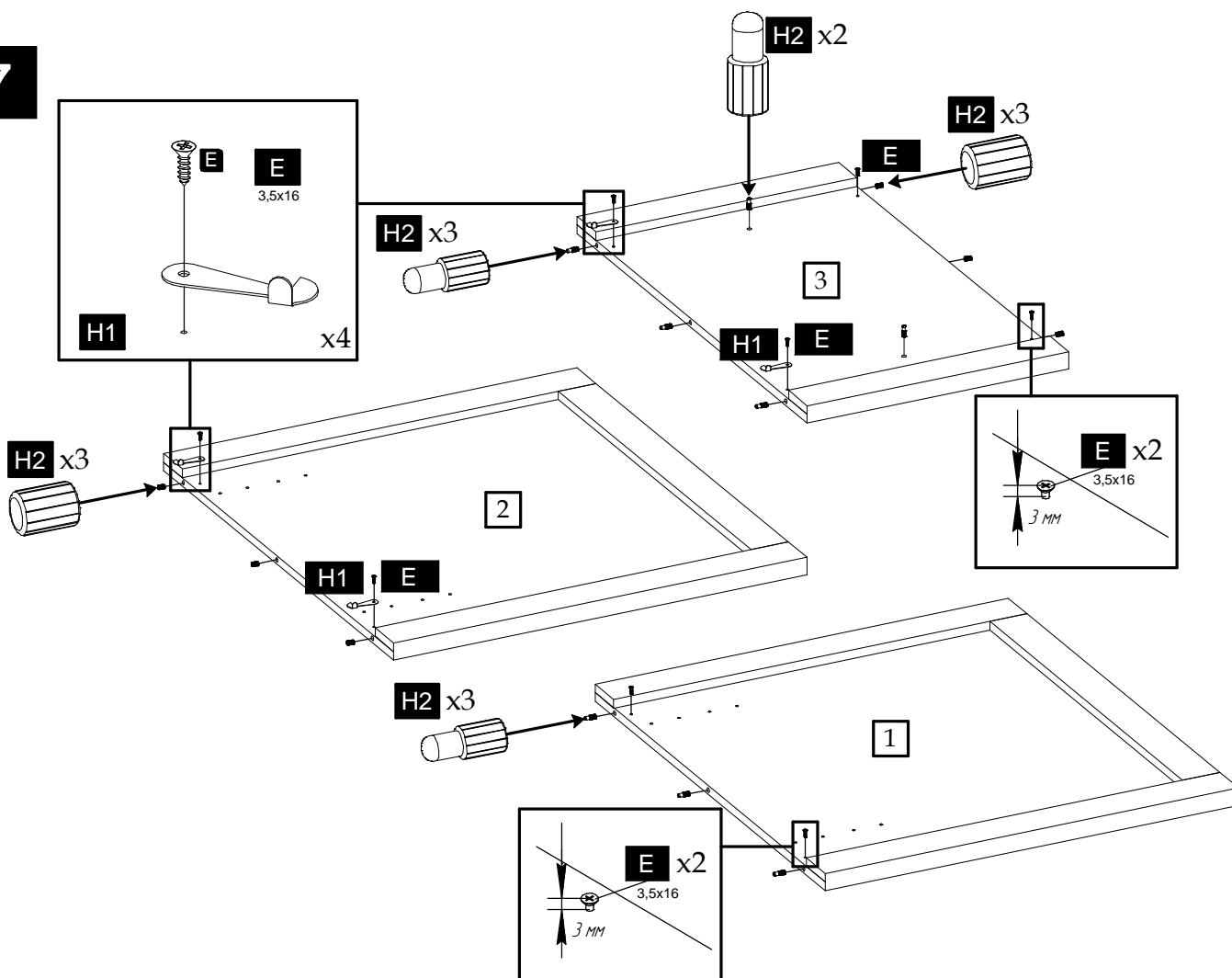
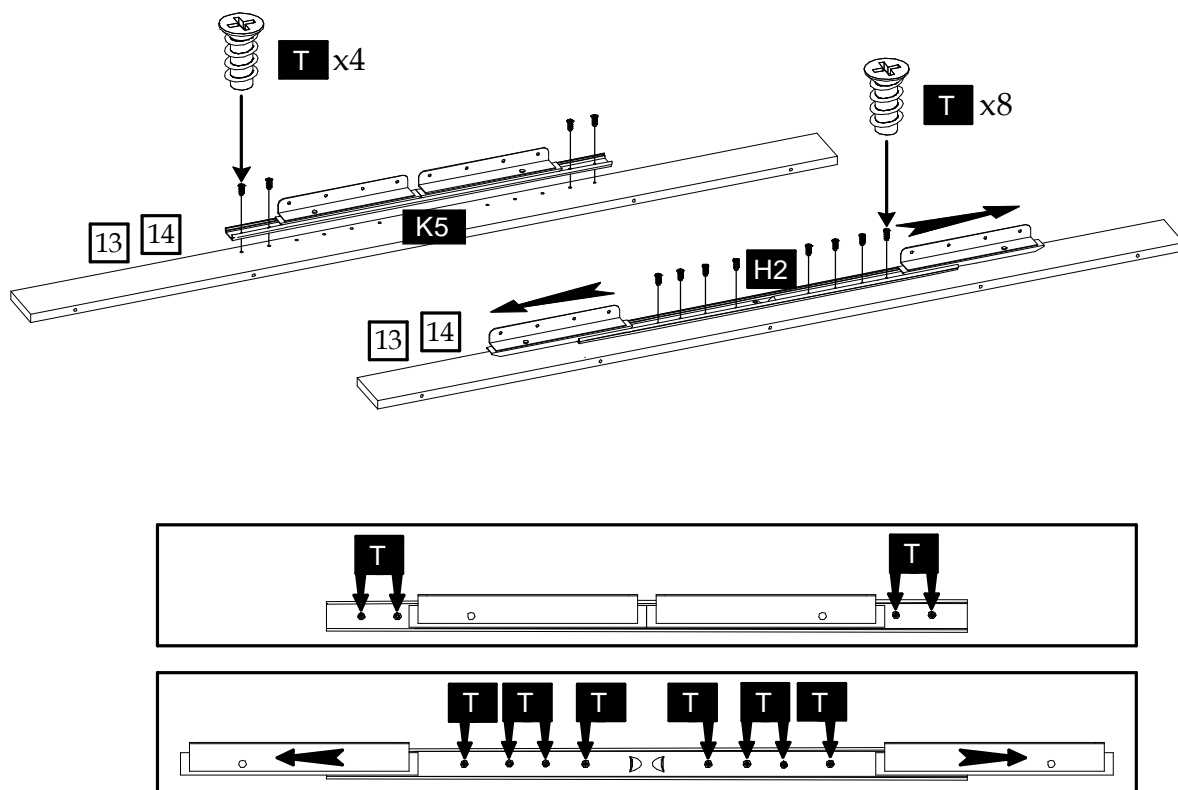

8

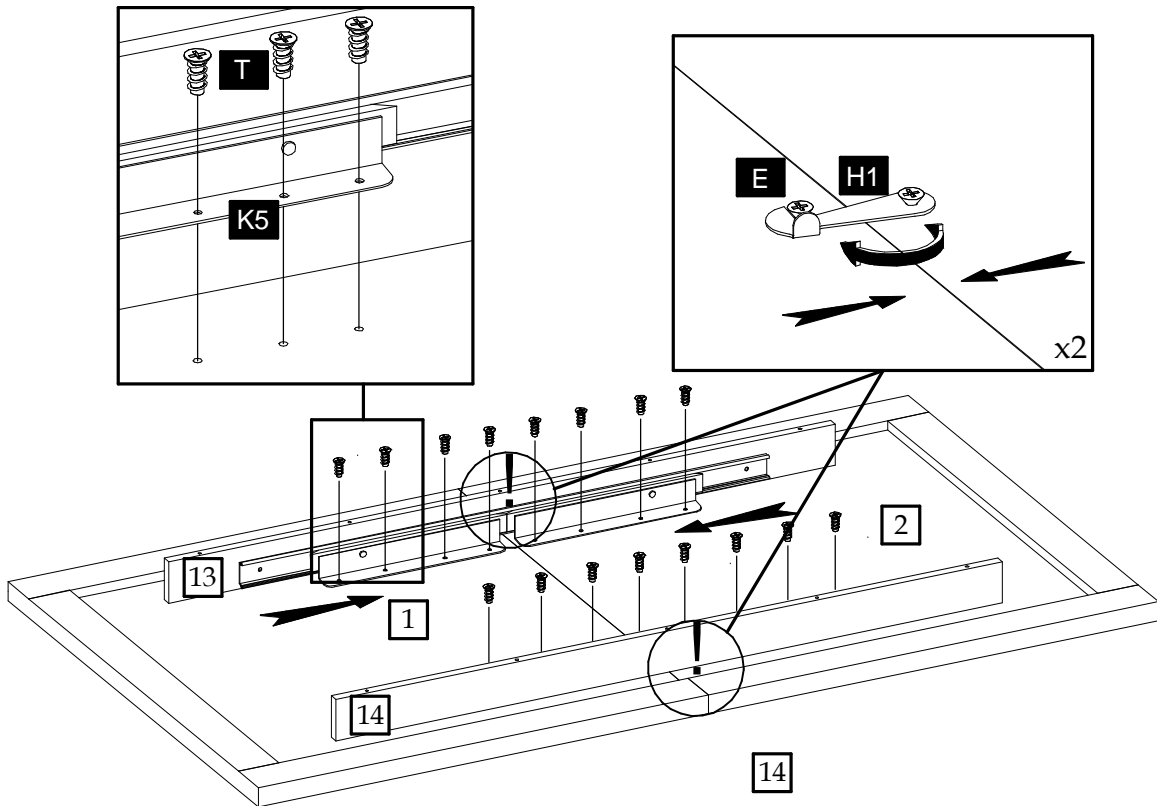

9

