

# Adam

## Typ C

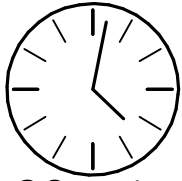

90 min

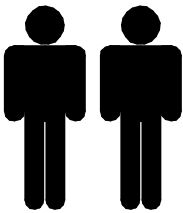

1617 mm

410 mm

900 mm

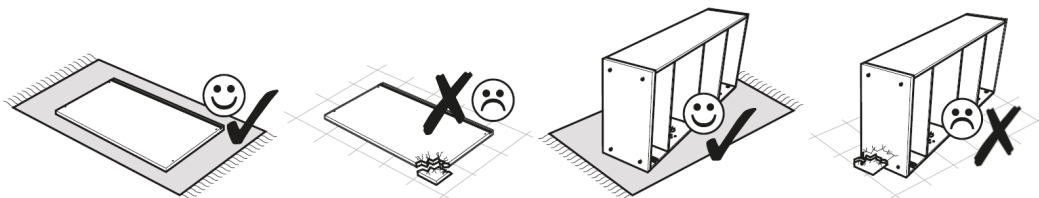
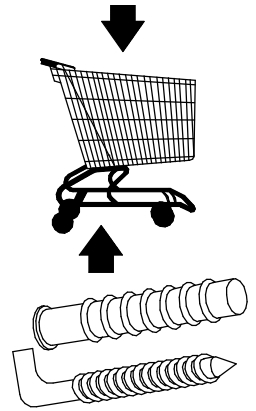
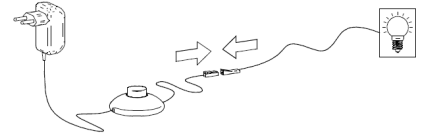

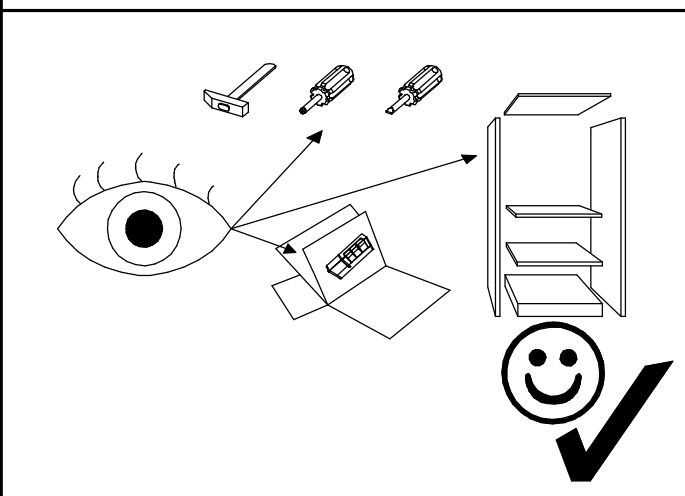
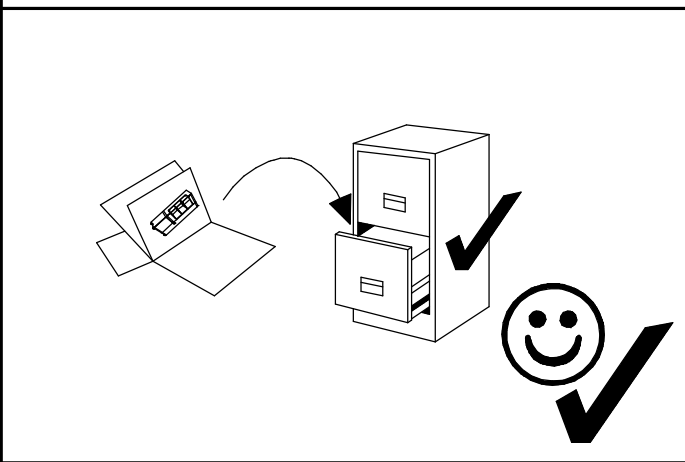
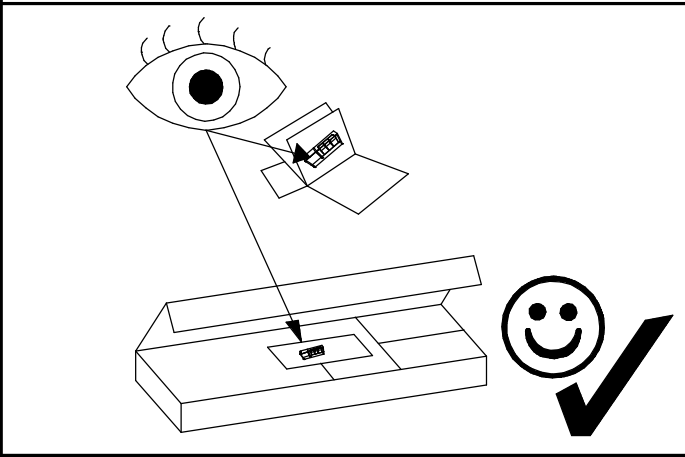

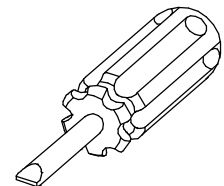
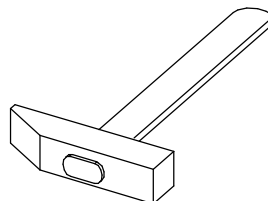
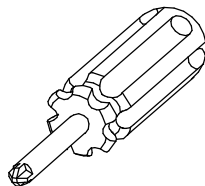
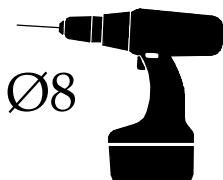
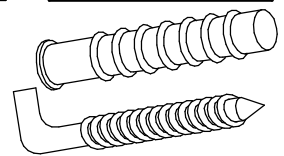
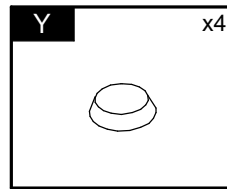
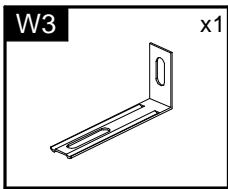
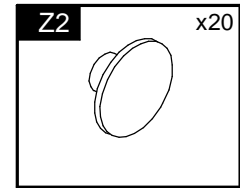
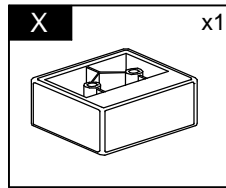
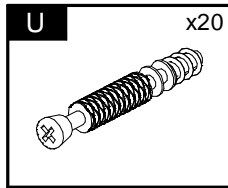
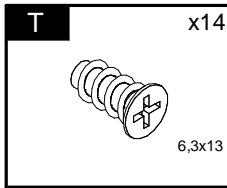
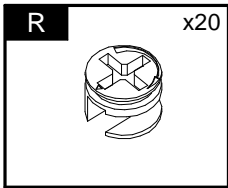
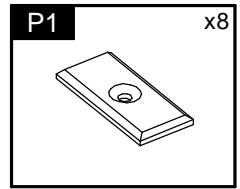
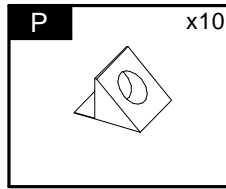
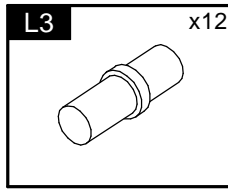
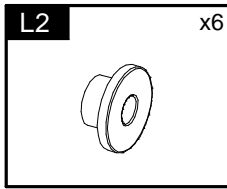
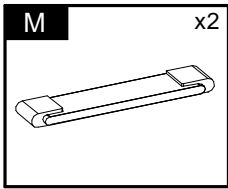
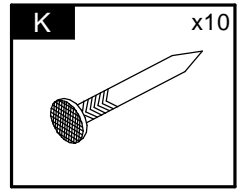
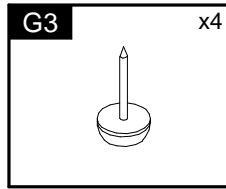
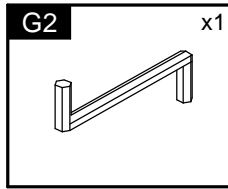
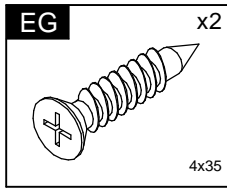
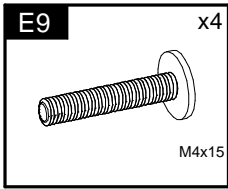
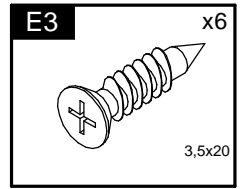
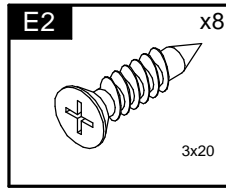
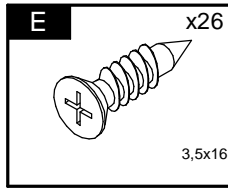
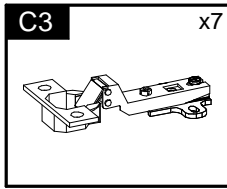
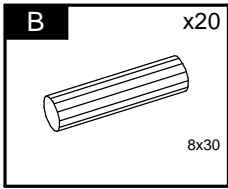
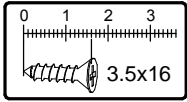

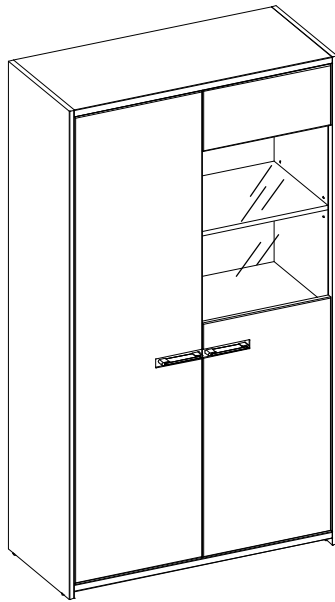

Element symbol	Measurements				Code	Paket
1	868	407.5	22	1	1005	2/4
2	868	387.5	22	1	1004/2004	2/4
3	1612	409.5	16	1	1002	1/4
4	1612	409.5	16	1	1003	1/4
5	868	368.5	16	1	1016/2016	1/4
6	435.5	367.5	16	1	1022	1/4
7	810.5	368	16	1	1027/2027	1/4
8	435.5	355	16	1	N/A	1/4
9	416.5	359.5	16	1	N/A	1/4
10	868	368.5	16	1	N/A	1/4
11	825	431	3	1	1030_v	3/4
12	825	450	3	1	N/A	3/4
13	748	441	3	2	N/A	3/4
14	1543	432	16	1	1007/3001	3/4
15	432	203	16	1	1018/3002	3/4
16	775	432	16	1	1010/3003	3/4
17	1035	500	4	1	Glass	4/4

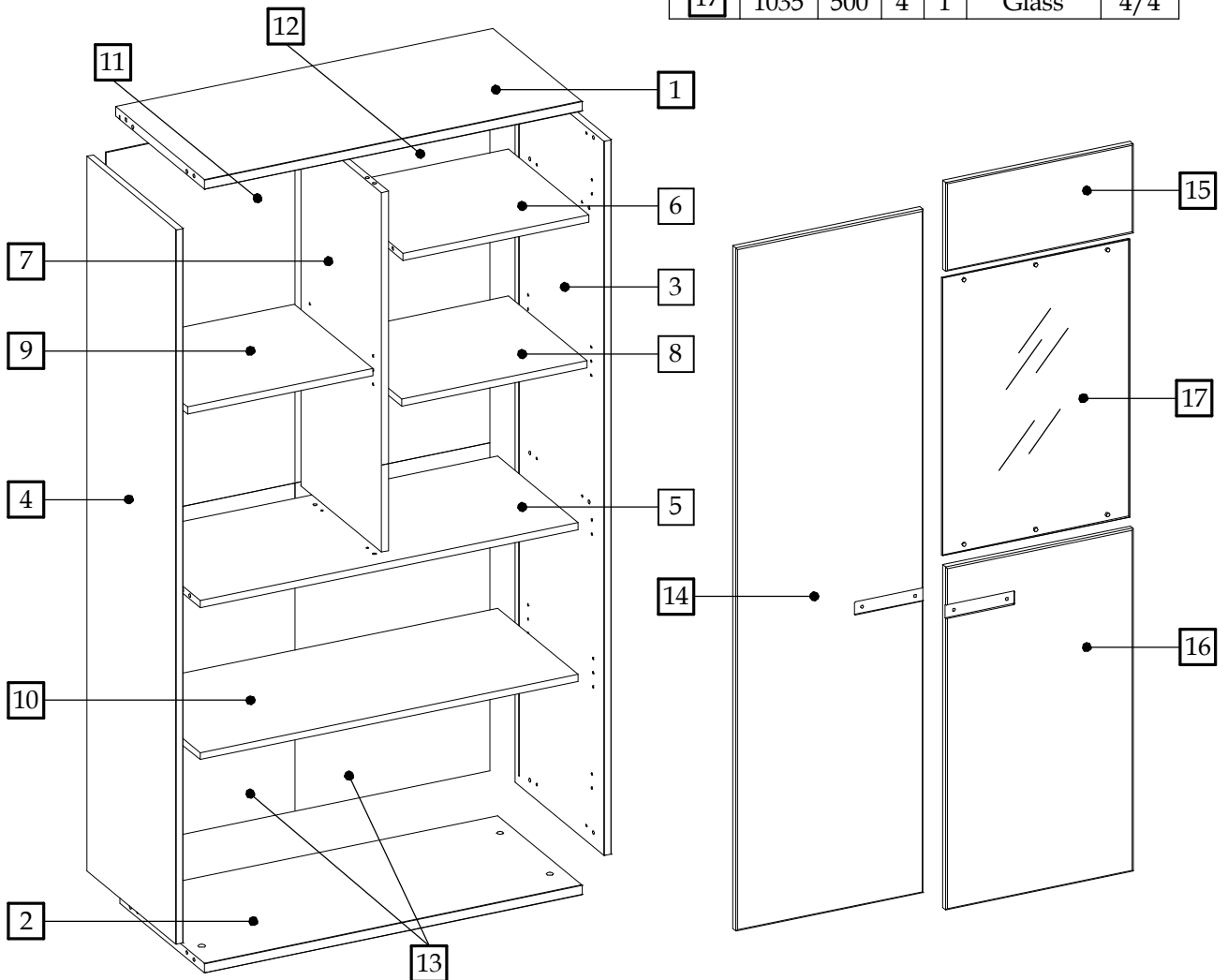

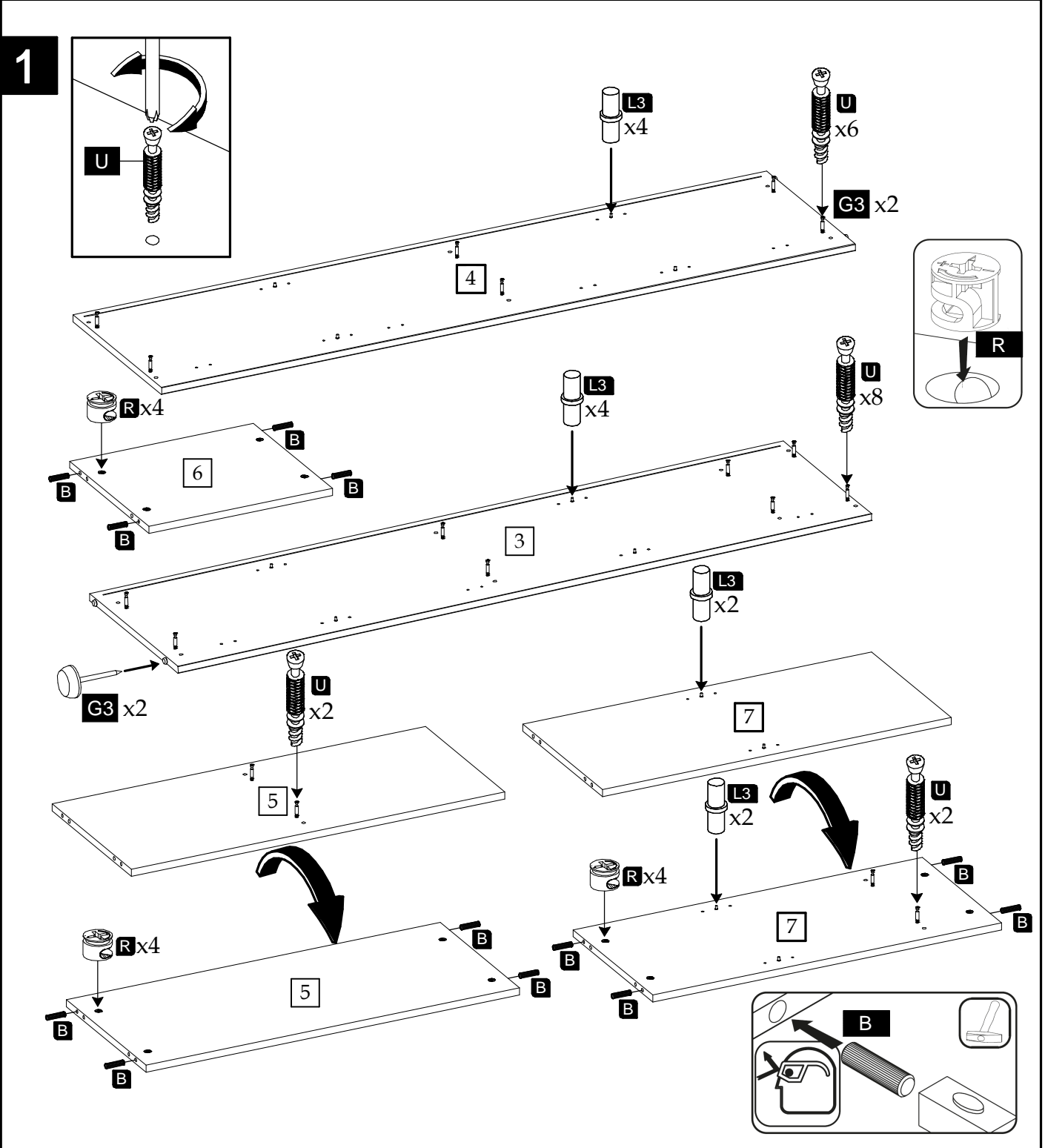
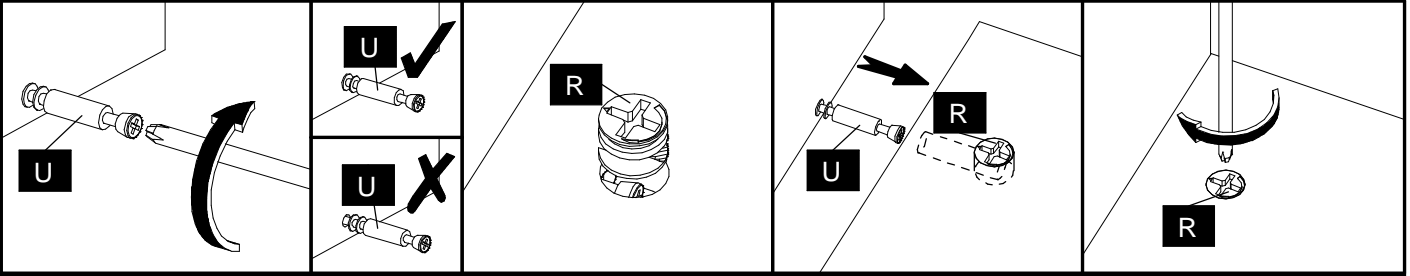

2

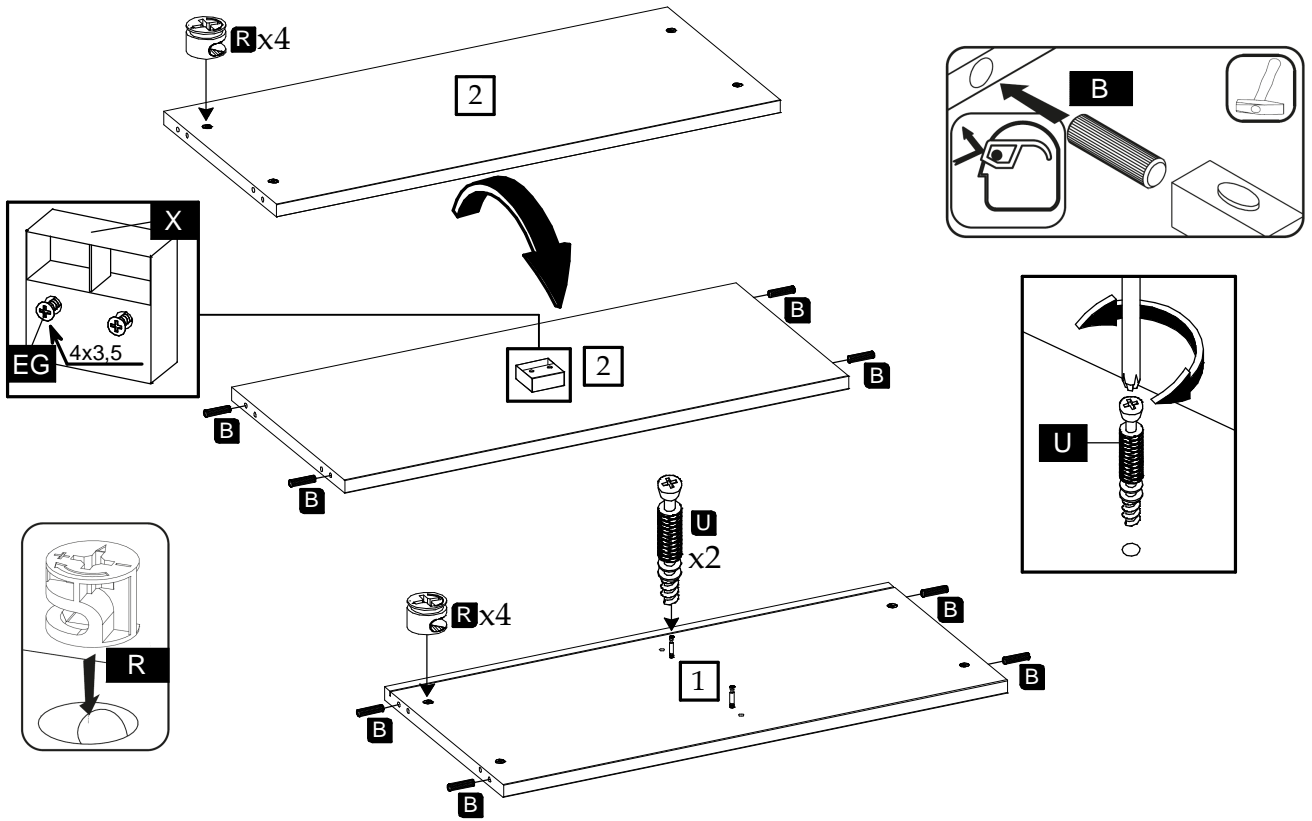

3

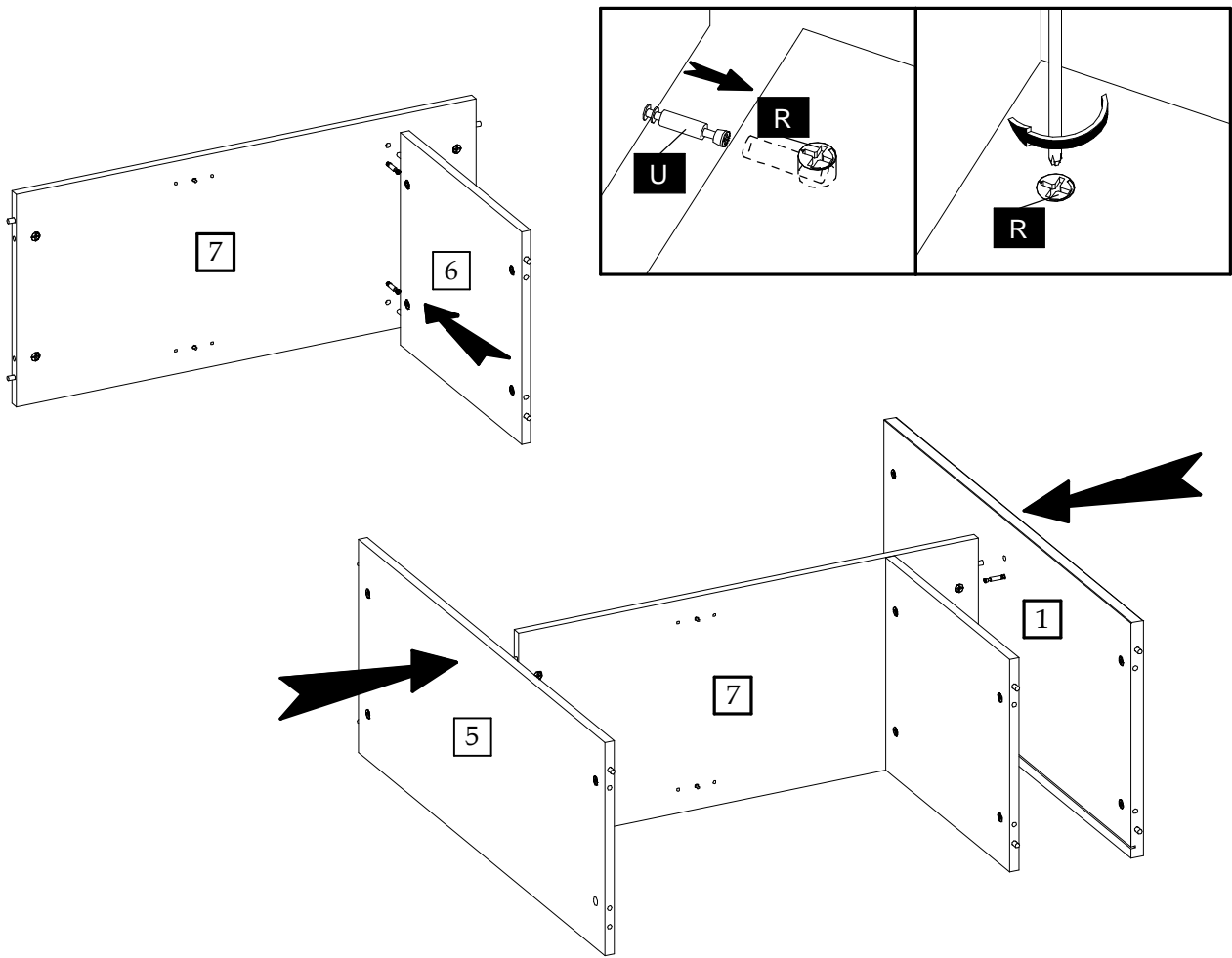

4

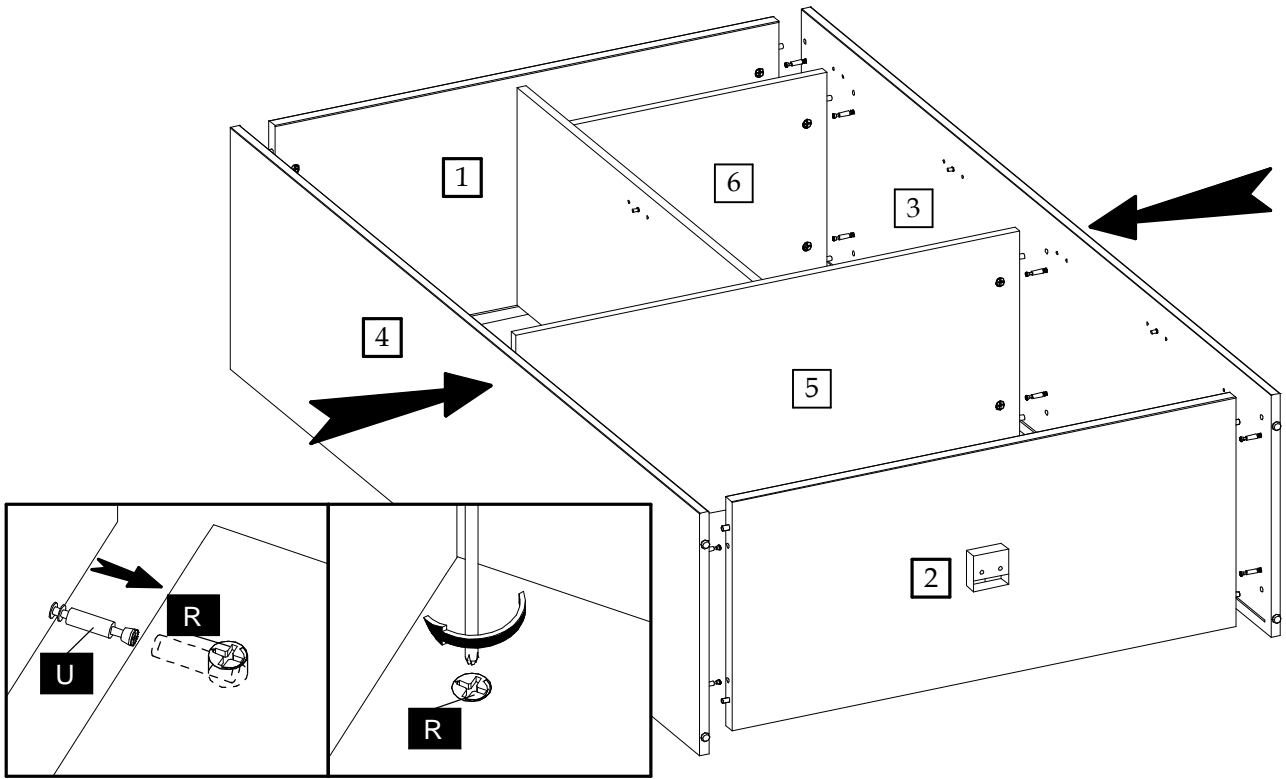

5

