

# Installation manual

## Shelf 155

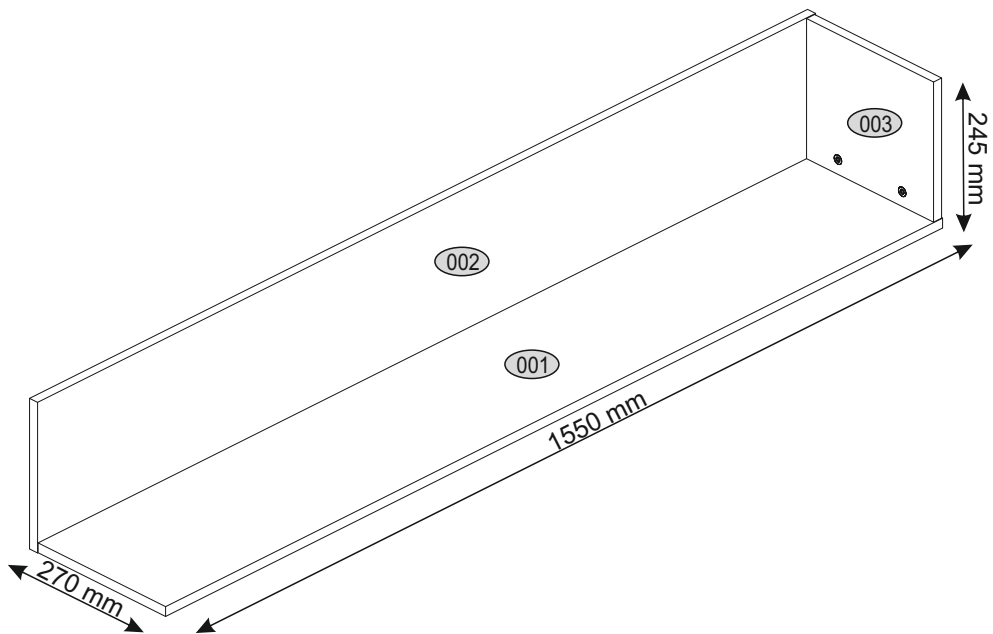
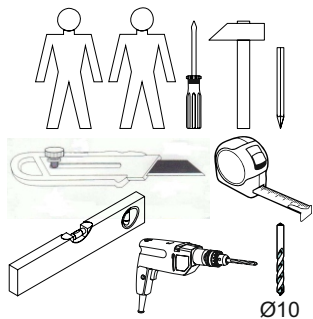
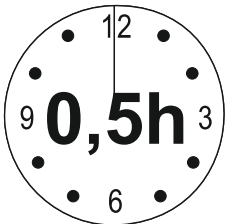

Code	Dimensions				Package
001	1248	245	16	1	1/1
002	1550	245	16	1	1/1
003	228	253	16	1	1/1
accessories				1	1/1

x8  
e1

Ø 7x50mm



x8  
f1

Ø 8x30mm



x2  
s2



x3  
g2



x2  
r16



x6  
e19

Ø6x9 mm



x2  
r1



x3  
e2

Ø6.3x13 mm



x1  
z1



x3  
f3

Ø10x50 mm



x3  
p17

Ø 5x60 mm

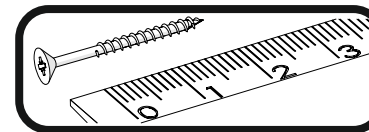
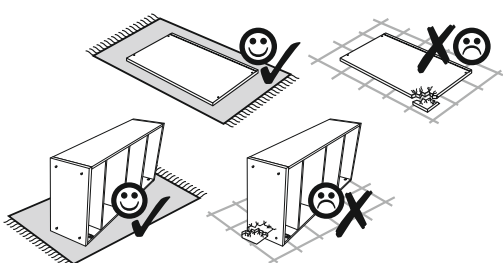
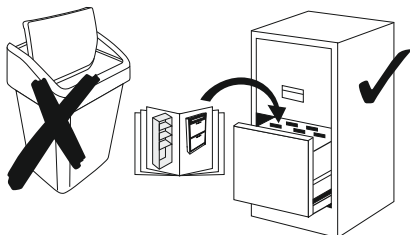

# 1

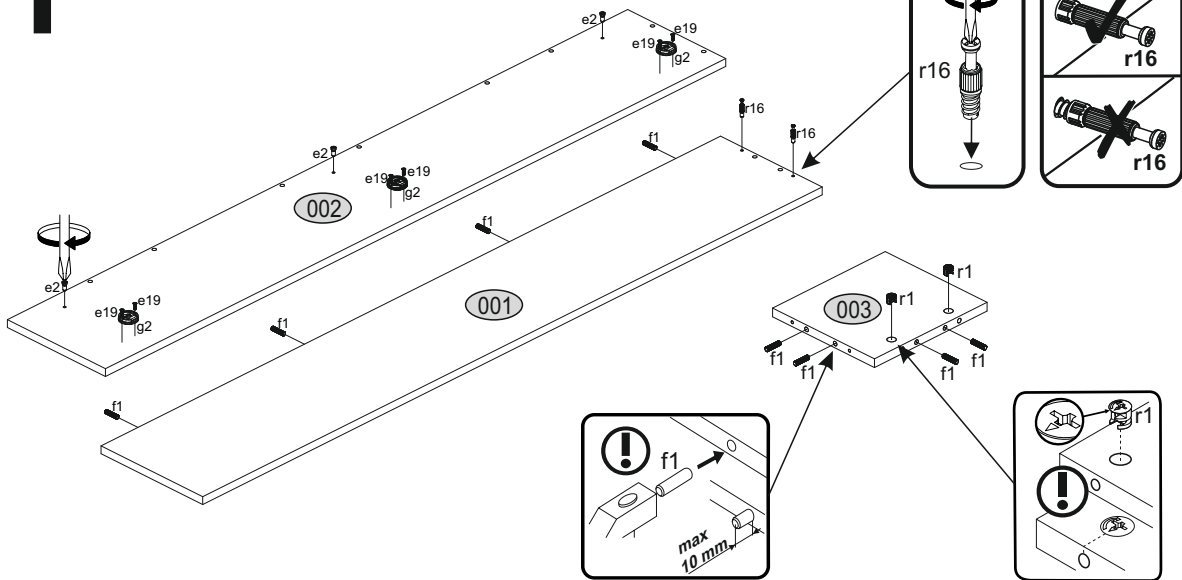

# 2

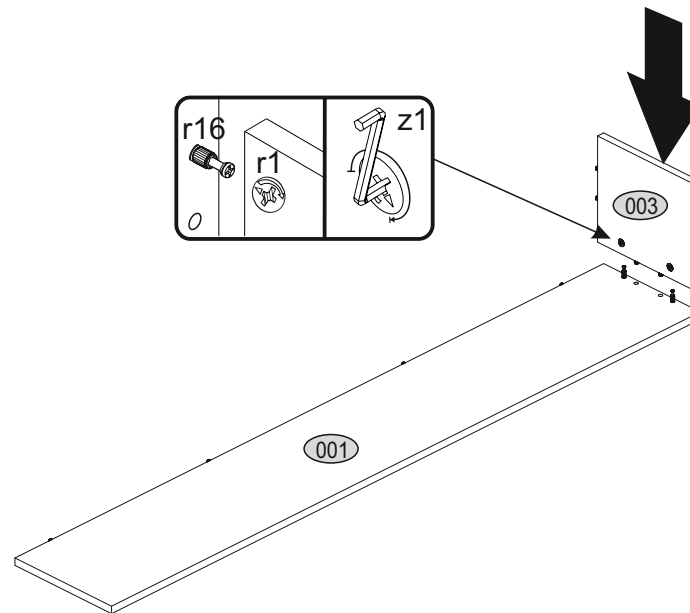

# 3

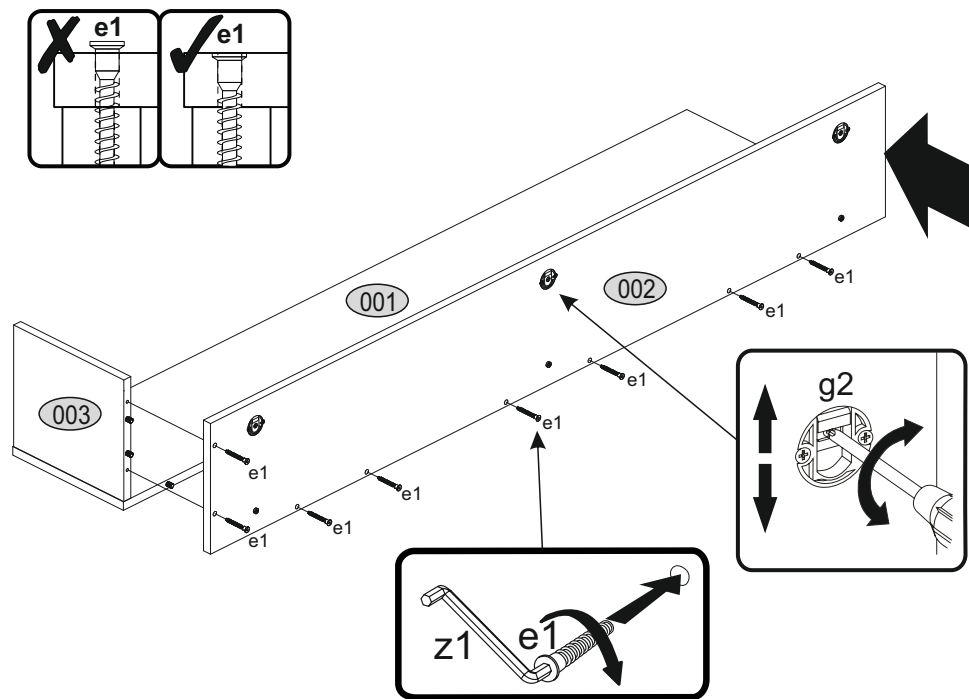

# 4

