

**Instructions for assembling furniture  
Instrukcja montażu mebli**

**Collection Kolecja mebli**

**«DOORSET»**

**Szafka RTV 2d1s/180**

**Sideboard RTV 2D1SN B**

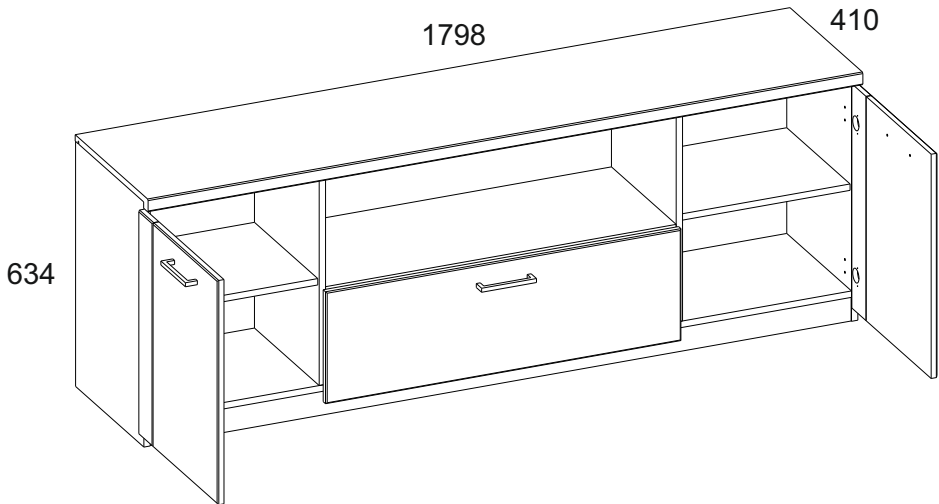

---

Production date  
Data produkcji

---

Stamp of Quality Department  
Pieczęć Działu Jakości

**PL**

### **Przy eksploatacji mebli zabrania się:**

- ustawiać meble w pobliżu grzewczych przyrządów i obok wilgotnych ścian, a także w pomieszczeniach ze względną wilgotnością więcej niż 70%;
- temperatura nagrzewania elementów mebli nie może przekraczać +40°C;
- w trakcie montażu i eksploatacji mebli stawać nogami na poziome panele i witryny;
- stosować chemiczne środki czyszczące do sprzątania mebli;
- nie należy narażać na kontakt z wodą.

### **Zapach.**

Nowe meble mogą wydzielać zapach materiałów, z których są wykonane. Zapach może utrzymywać się do trzech tygodni od momentu montażu. Aby zmniejszyć intensywność zapachu, zaleca się:

- w przypadku mebli tapicerowanych - odkurzyć produkt i przewietrzyć pomieszczenie. Powtarzaj 3-4 razy dziennie.
- dla mebli szafkowych - przetrzyj ściereczką zwilżoną łagodnym detergentem, przetrzyj czystą, suchą ściereczką i przewietrz pomieszczenie, uprzednio otwierając wszystkie drzwi i szuflady produktu. Powtarzaj 3-4 razy dziennie.

**Ważne!** Proszę zachować instrukcję w razie ponownego montażu mebli lub reklamacji. Podczas składania reklamacji prosimy o korzystanie z oznaczeń z instrukcji.

**DE**

### **Bei der Benutzung der Möbel ist es verboten:**

- Möbel in der Nähe von Heizgeräten und neben feuchten Wänden sowie in Räumen mit einer relativen Luftfeuchtigkeit von mehr als 70 % aufstellen;
- Heiztemperatur von Möbelementen darf + 40 ° C nicht überschreiten;
- Stellen Sie sich während der Montage und Verwendung von Möbeln mit den Füßen auf die horizontalen Paneele und Fenster;
- zur Reinigung von Möbeln chemische Reinigungsmittel verwenden;
- sollte keinem Wasser ausgesetzt werden.

### **Geruch.**

Neue Möbel können nach den Materialien riechen, aus denen sie bestehen. Der Duft kann bis zu drei Wochen nach der Installation anhalten. Um die Intensität des Duftes zu verringern, wird empfohlen:

- bei Polstermöbeln das Produkt absaugen und den Raum lüften. 3-4 mal täglich wiederholen.
- für Schrankmöbel - mit einem milden Reinigungsmittel angefeuchteten Tuch abwischen, mit einem sauberen, trockenen Tuch abwischen und den Raum lüften, indem Sie zuerst alle Türen und Schubladen des Produkts öffnen. 3-4 mal täglich wiederholen.

**Wichtig!** Bitte bewahren Sie die Anleitung für den Fall eines Möbelumbaus oder einer Reklamation auf. Bitte verwenden Sie bei einer Reklamation die Markierungen im Handbuch.

**FR**

### **Lors de l'utilisation du mobilier, il est interdit de :**

- placez les meubles à proximité d'appareils de chauffage et à côté de murs humides, ainsi que dans des pièces dont l'humidité relative est supérieure à 70 % ;
- la température de chauffage des éléments de mobilier ne doit pas dépasser + 40 ° C ;
- lors du montage et de l'utilisation des meubles, placez vos pieds sur les panneaux horizontaux et les fenêtres ;
- utiliser des produits de nettoyage chimiques pour nettoyer les meubles ;
- ne doit pas être exposé à l'eau.

### **Sentir.**

Les nouveaux meubles peuvent dégager une odeur des matériaux dont ils sont faits. L'odeur peut persister jusqu'à trois semaines après l'installation. Pour réduire l'intensité du parfum, il est recommandé de :

- dans le cas de meubles rembourrés - aspirer le produit et aérer la pièce. Répétez 3-4 fois par jour.
- pour les meubles de rangement - essayez avec un chiffon imbibé d'un détergent doux, essayez avec un chiffon propre et sec et aérez la pièce en ouvrant d'abord toutes les portes et tous les tiroirs du produit. Répétez 3-4 fois par jour.

**Important!** Veuillez conserver la notice en cas de remontage du meuble ou de réclamation. Lorsque vous soumettez une plainte, veuillez utiliser les marquages dans le manuel.

**EN**

**When using the furniture, it is forbidden to:**

- place furniture near heating devices and next to damp walls, as well as in rooms with a relative humidity of more than 70%;
- heating temperature of furniture elements must not exceed + 40 ° C;
- during the assembly and use of furniture, stand with your feet on the horizontal panels and windows;
- use chemical cleaning agents to clean furniture;
- should not be exposed to water.

**Smell.**

New furniture can give off a smell of the materials it is made of. The scent may persist for up to three weeks after installation. To reduce the intensity of the fragrance, it is recommended to:

- in the case of upholstered furniture - vacuum the product and ventilate the room.

Repeat 3-4 times a day.

-for cabinet furniture - wipe with a cloth dampened with a mild detergent, wipe with a clean, dry cloth and ventilate the room, first opening all doors and drawers of the product.

Repeat 3-4 times a day.

**Important!** Please keep the instructions in the event of furniture reassembly or complaints. When submitting a complaint, please use the markings in the manual.

**SPA**

**Al utilizar los muebles, está prohibido:**

- colocar muebles cerca de aparatos de calefacción y junto a paredes húmedas, así como en habitaciones con una humedad relativa superior al 70%;
- la temperatura de calentamiento de los elementos del mobiliario no debe exceder los + 40 ° C;
- durante el montaje y uso de los muebles, párese con los pies sobre los paneles horizontales y las ventanas;
- utilizar agentes de limpieza químicos para limpiar los muebles;
- No debe exponerse al agua.

**Olor.**

Los muebles nuevos pueden desprender el olor de los materiales de los que están hechos. El olor puede persistir hasta tres semanas después de la instalación. Para reducir la intensidad de la fragancia, se recomienda:

- en el caso de muebles tapizados - aspirar el producto y ventilar la estancia.

Repita 3-4 veces al día.

-para muebles de gabinete - limpie con un paño humedecido con un detergente suave, limpie con un paño limpio y seco y ventile la habitación, abriendo primero todas las puertas y cajones del producto.





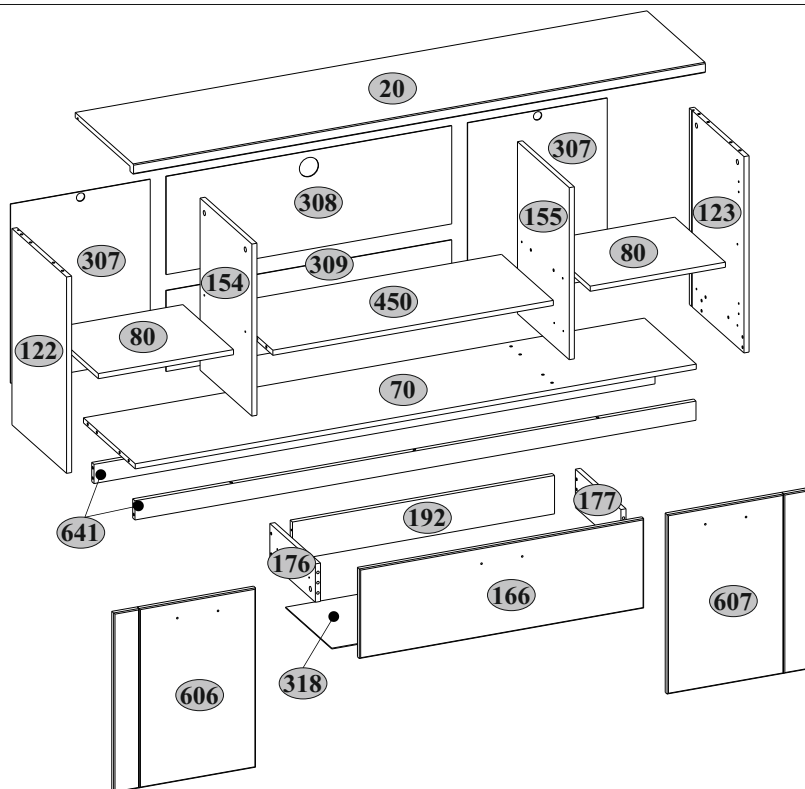







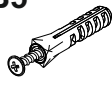
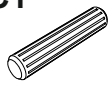
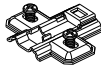
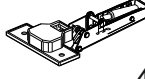



Repita 3-4 veces al día.

**Importante!** Conserve las instrucciones en caso de reensamblaje de muebles o reclamaciones. Al enviar una queja, utilice las marcas en el manual.

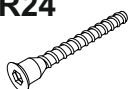

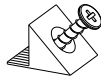
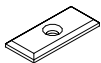

№	L, mm	B, mm	H, mm	Q	№ pack
20	1798	410	32	1	2/2
70	1764	364	16	1	2/2
80	425	356	16	2	1/2
122	614	384	16	1	1/2
123	614	384	16	1	1/2
154	538	364	16	1	1/2
155	538	364	16	1	1/2
166	894	280	16	1	2/2
176	320	120	16	1	1/2
177	320	120	16	1	1/2
192	824	120	16	1	2/2
307	560	439	2,5	2	1/2
308	307	898	2,5	1	2/2
309	253	898	2,5	1	2/2
318	854	325	2,5	1	2/2
450	882	364	16	1	2/2
606	561	446	16	1	1/2
607	561	446	16	1	1/2
641	1764	60	16	2	2/2

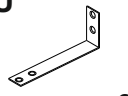
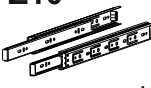

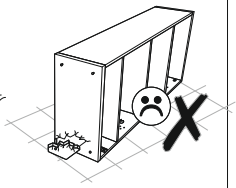
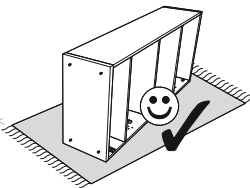
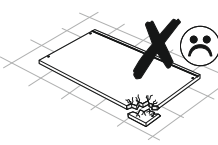
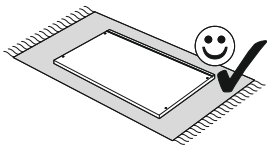
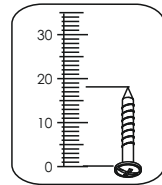
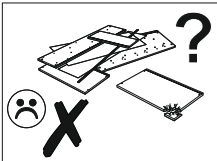
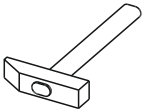
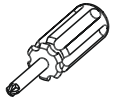
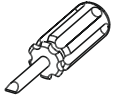
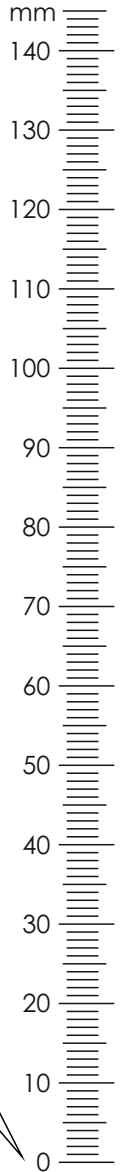
<b>A1</b>  7x34 20	<b>A2</b>  Ø15x12 20	<b>B5</b>  10x50 2	<b>C1</b>  8x35 38
<b>D1-1</b>  4	<b>E1-1</b>  4	<b>I</b>  S4 1	<b>H58</b>  3
<b>L1</b>  320 2	<b>N1</b>  8	<b>P5</b>  8	<b>R3</b>  3x20 28
<b>R23</b>  6,3x13 8	<b>R24</b>  7x50 8	<b>R27</b>  5,0x13 10	<b>R32</b>  4x27 6
<b>R102</b>  3,5x16 16	<b>S1</b>  12	<b>S3</b>  10	<b>S5</b>  Ø18 12
<b>U</b>  130x35x15 2	<b>Z10</b>  300 1		

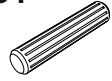

1

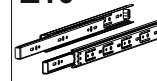
<b>A1</b>  7x34	<b>C1</b>  4 8x35	<b>P5</b>  8	<b>R27</b>  4 5,0x13	<b>Z10</b>  6 300 1
--	--	---	---	--

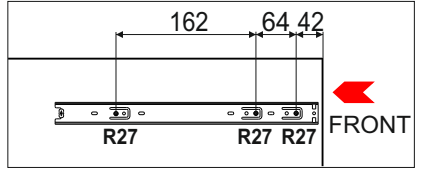
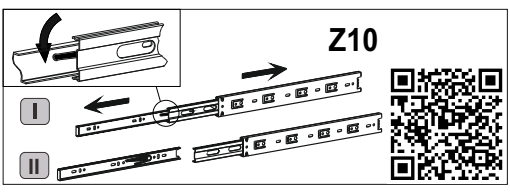
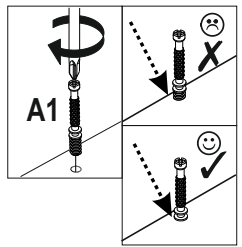
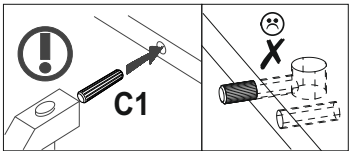
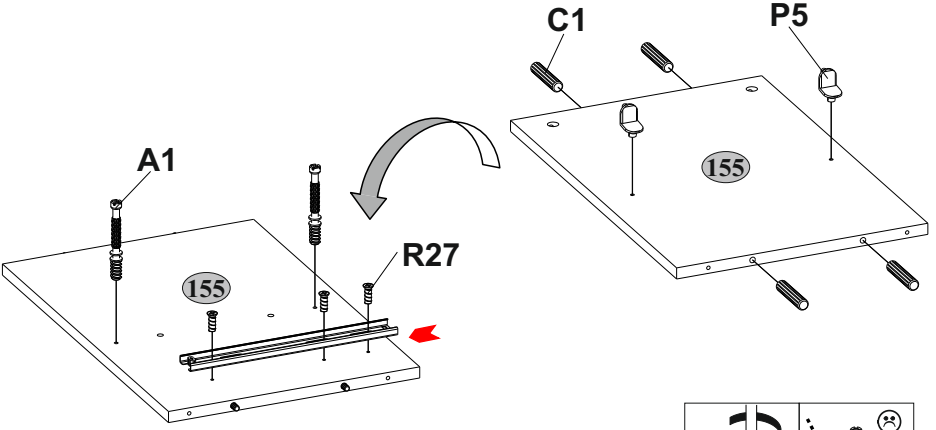
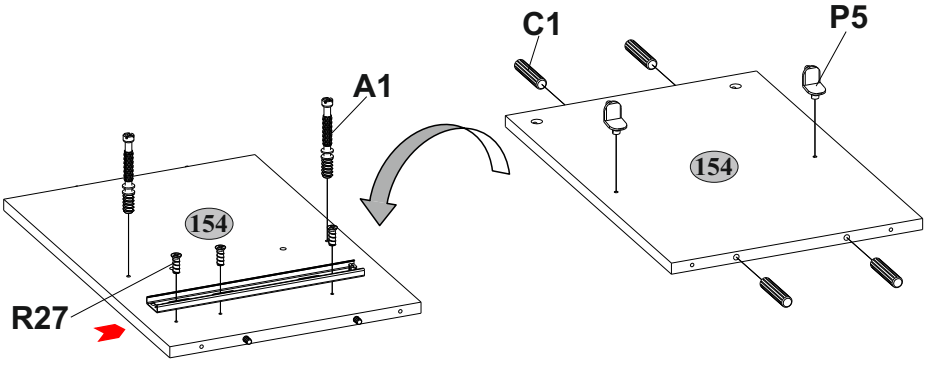

2

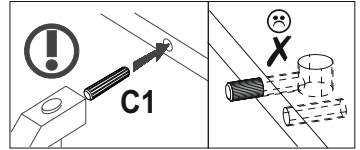
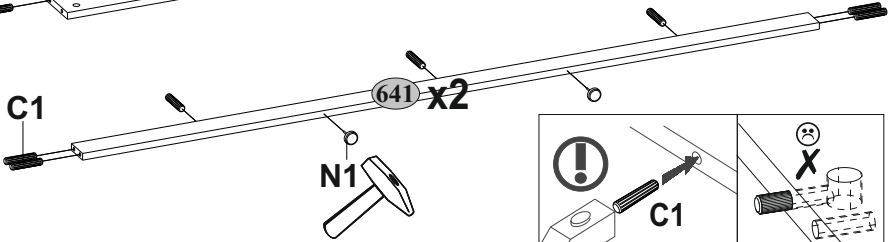
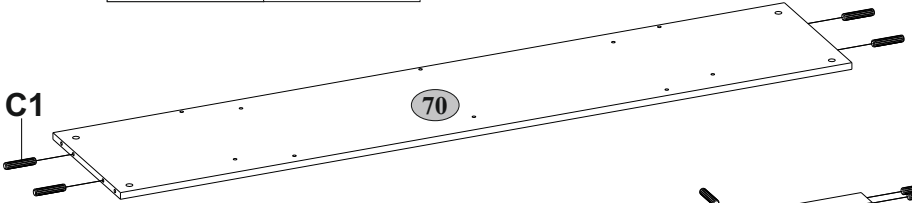
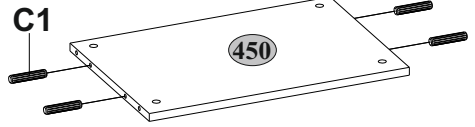
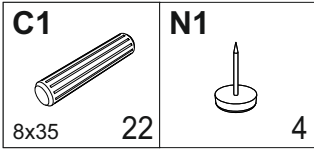

3

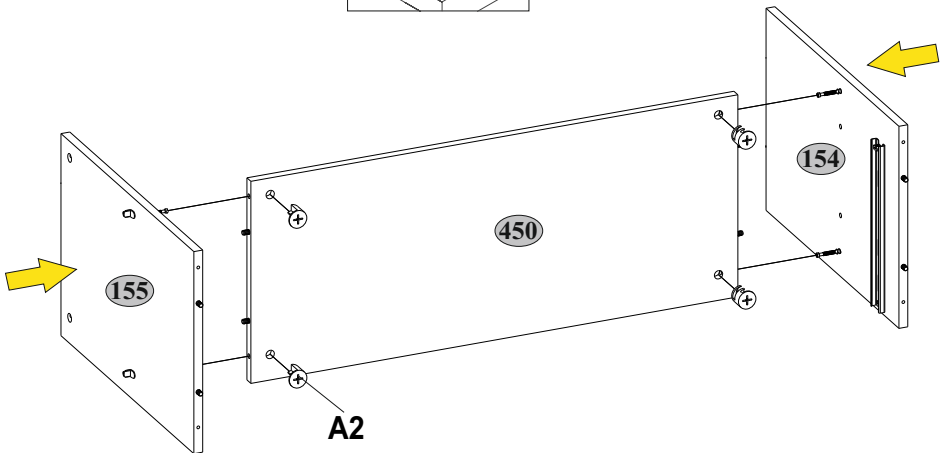
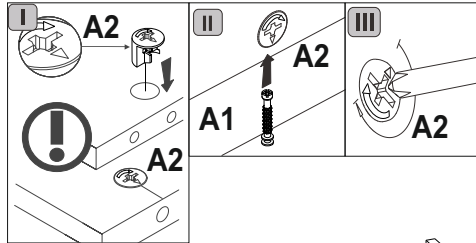
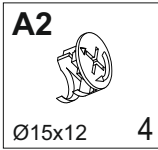

4

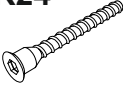
I	R24
	
S4	1 7x50 4

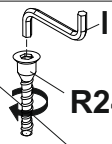

R24

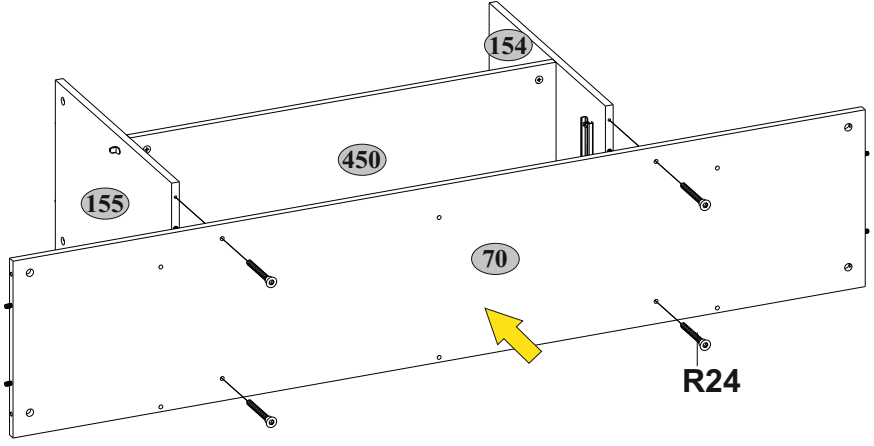

5

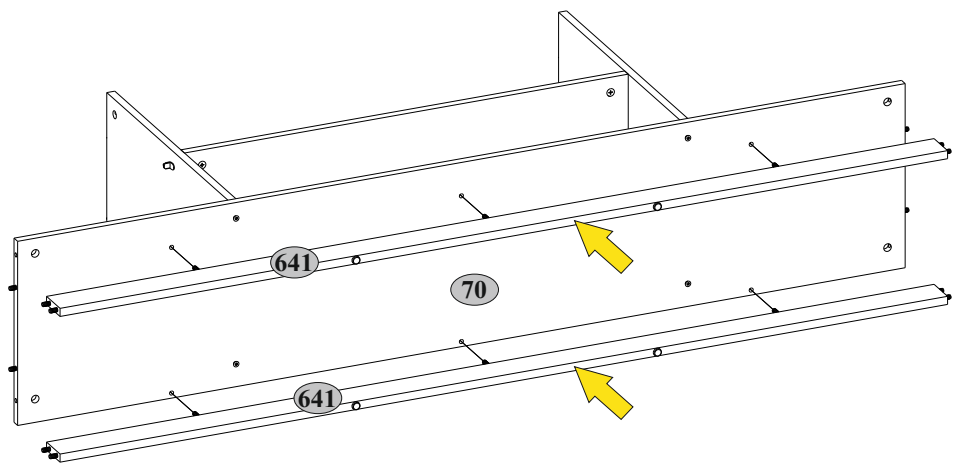



**6****A1**

7x34

4

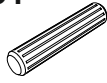
**C1**

8x35

4

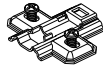
**D1-1**

4

**N1**

4

**P5**

4

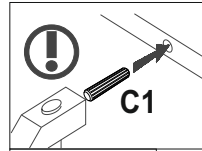
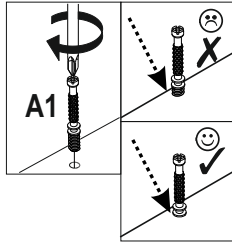
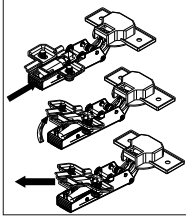
**E1-1+D1-1****R23**

6,3x13

8

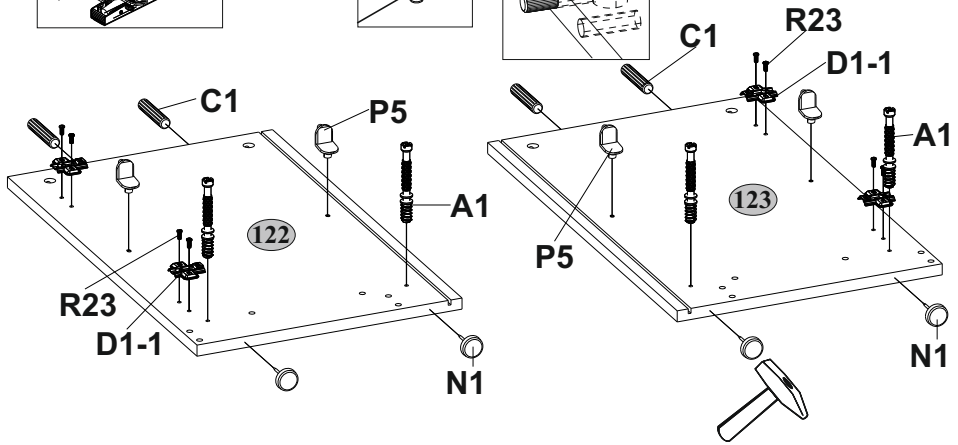
**7****A2**

Ø15x12

4

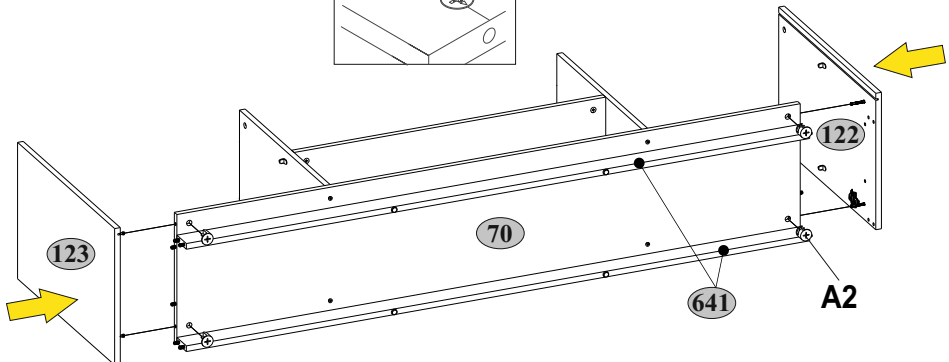
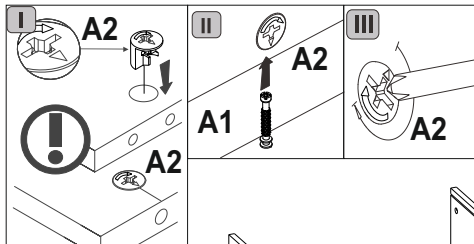

8

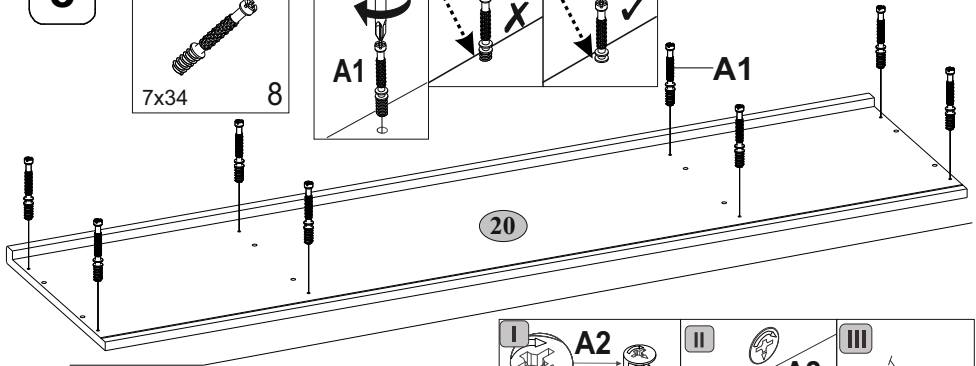
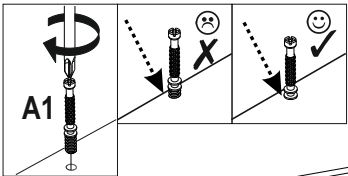
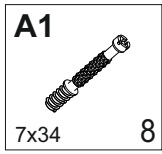

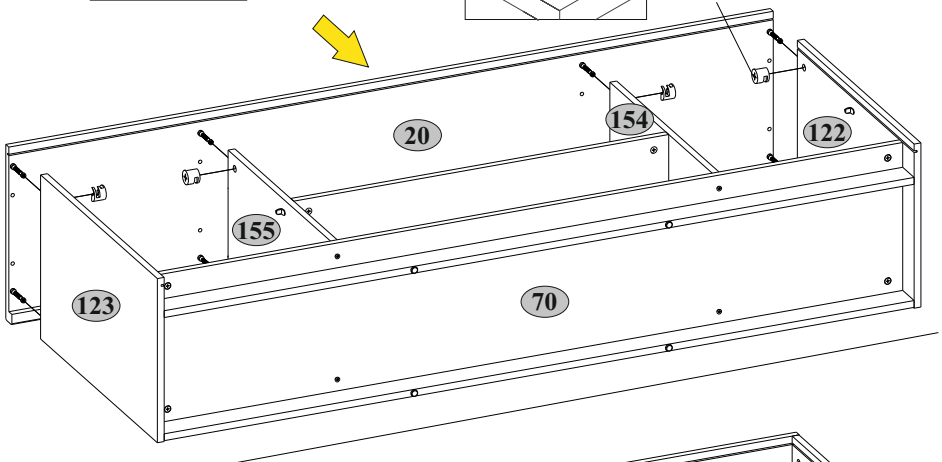
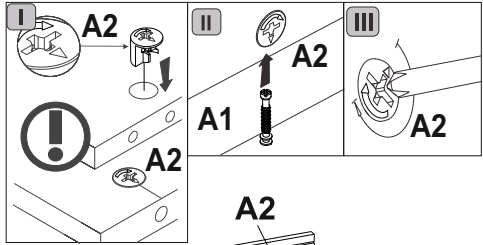
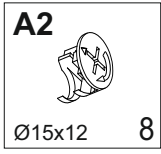

9

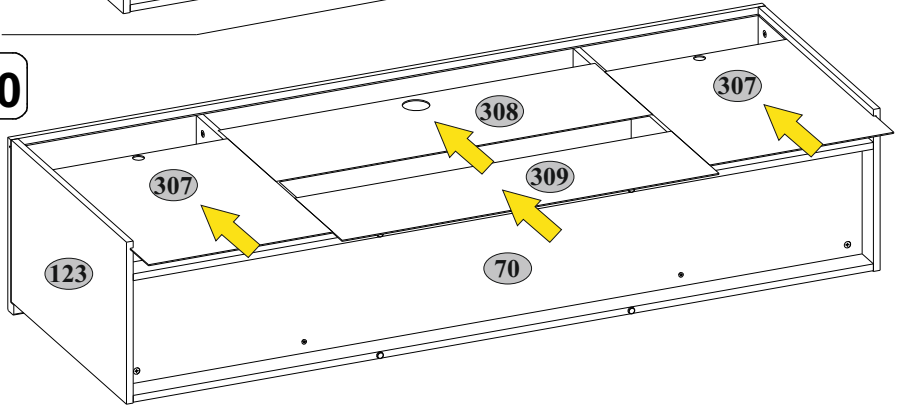

10





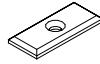
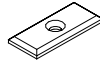

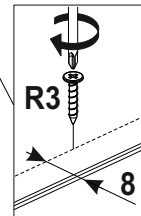
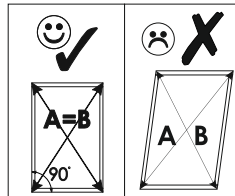
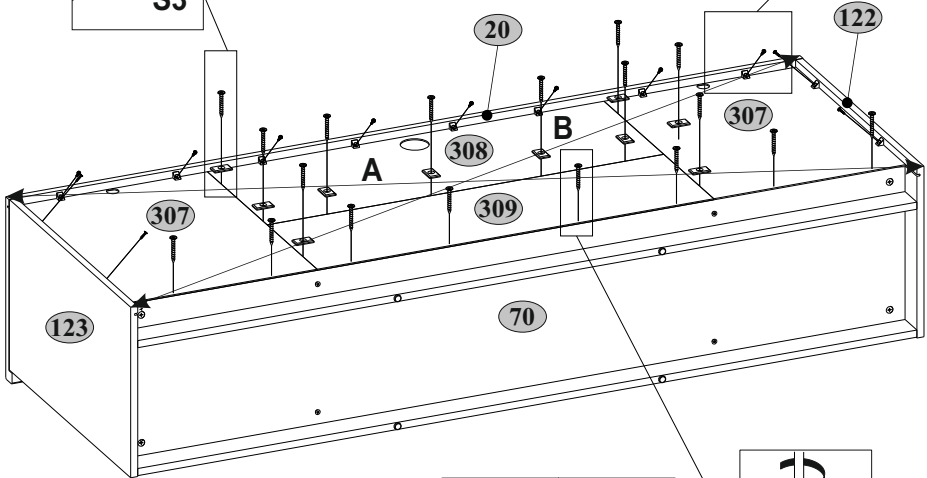
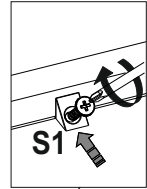
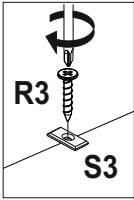

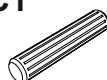

11

<b>R3</b>  3x20	<b>S1</b>  18	<b>S3</b>  12	<b>S3</b>  10
--	--	--	--



12

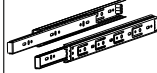

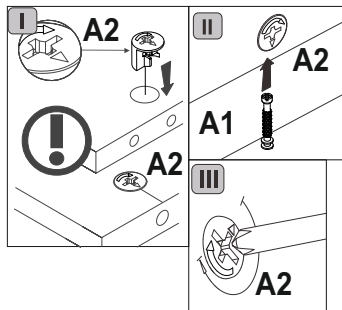
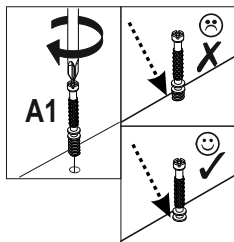
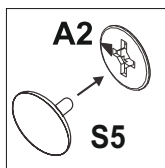
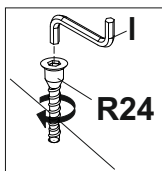
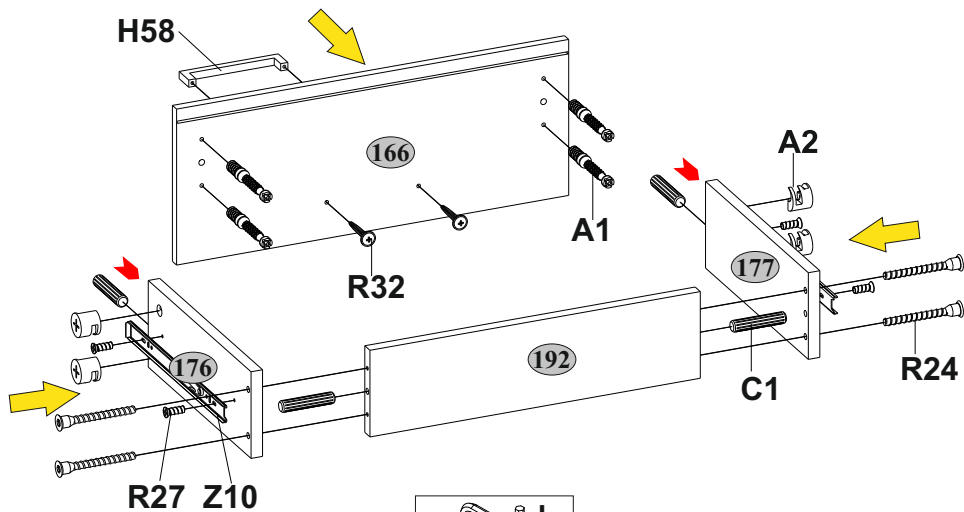
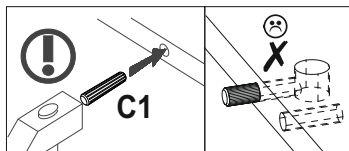
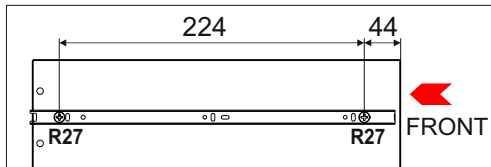
<b>A1</b>  7x34 4	<b>A2</b>  Ø15x12 4	<b>C1</b>  8x35 4	<b>I</b>  S4 1	<b>H58</b>  1
<b>R24</b>  7x50 4	<b>R27</b>  5,0x13 4	<b>R32</b>  4x27 2	<b>S5</b>  Ø18 4	<b>Z10</b>  300 1

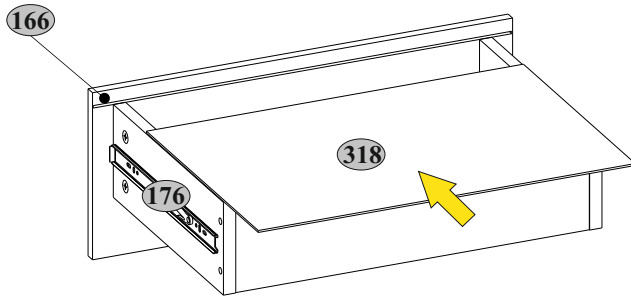

13



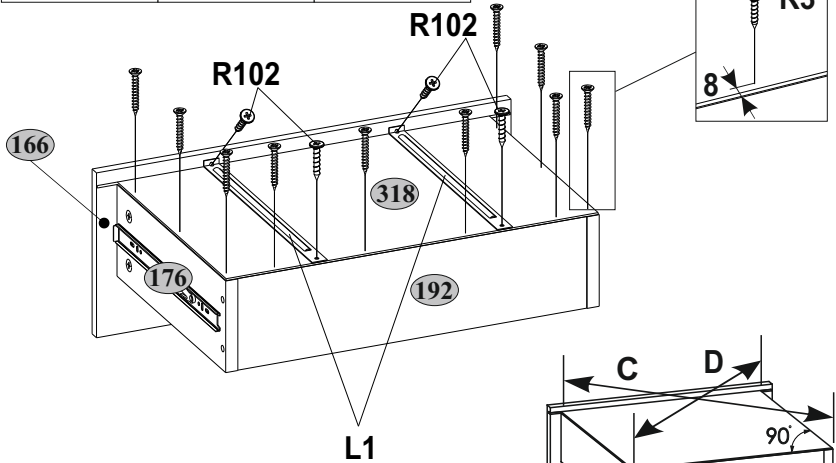

14

<b>L1</b>  320 2	<b>R3</b>  3x20 10	<b>R102</b>  3,5x16 4
---	---	--





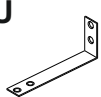

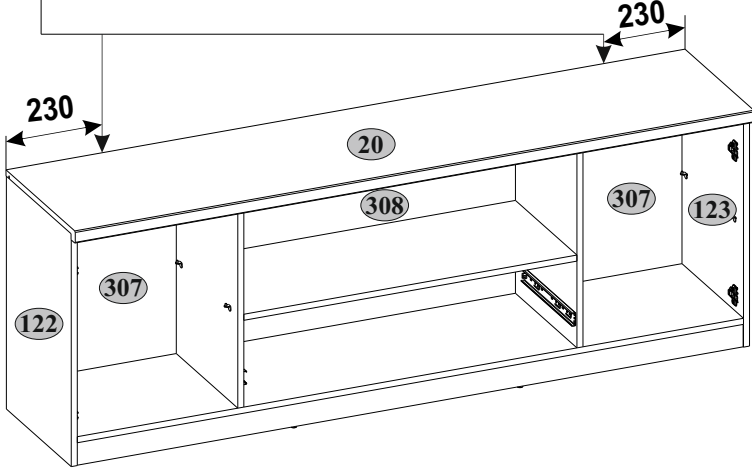
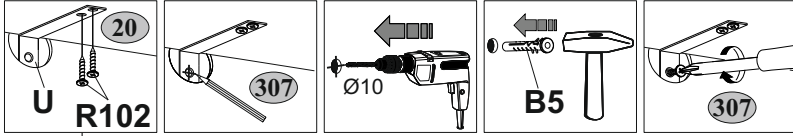
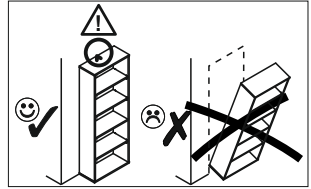
15

<b>B5</b>  10x50	<b>R102</b>  3,5x16	<b>U</b>  130x35x15
2	4	2

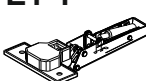

16

<b>E1-1</b>  4	<b>H58</b>  2	<b>R32</b>  4x27
	<b>R102</b>  3,5x16	4
	8	

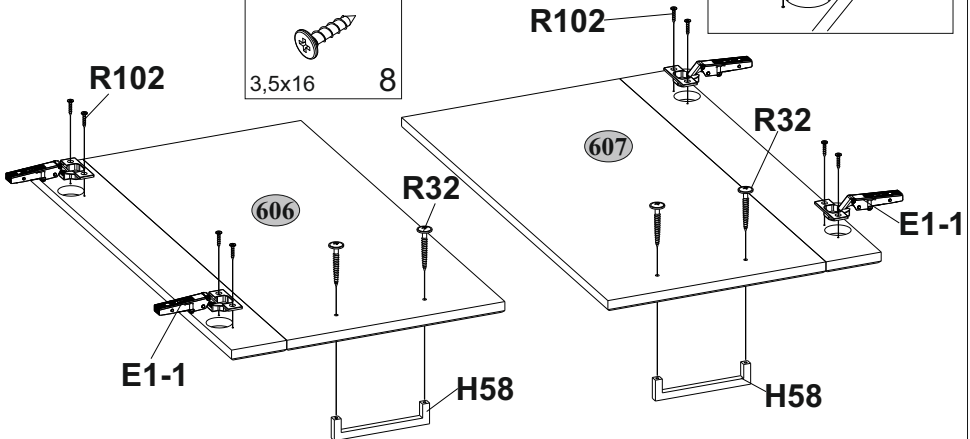
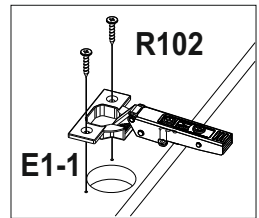

17

S5



Ø18

8

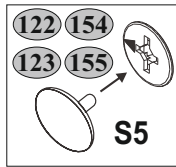

S5

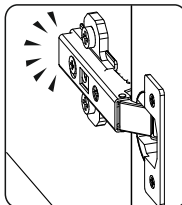
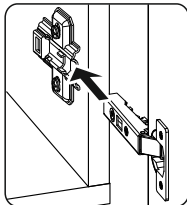
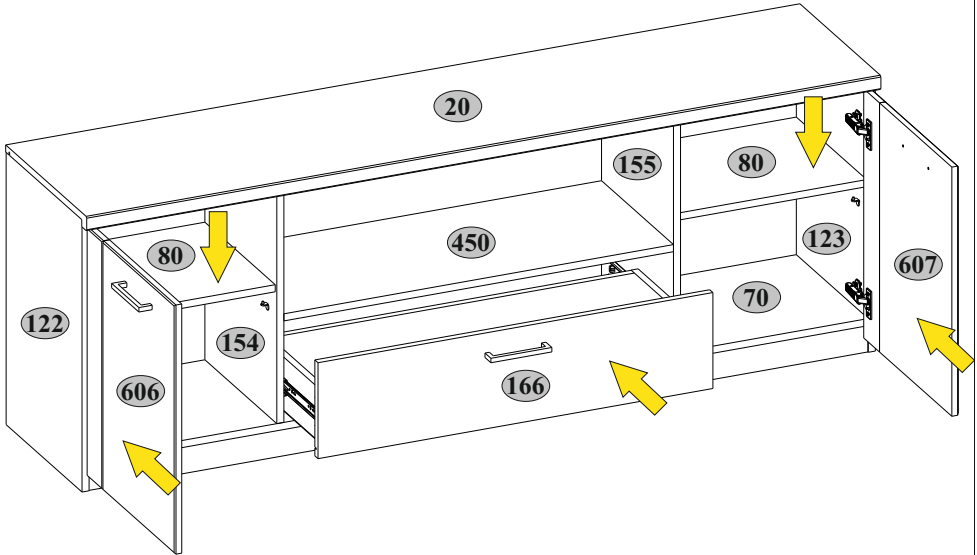

450 80 166  max. 5 kg

20 70  max. 10 kg

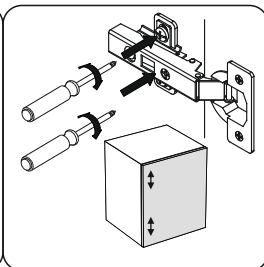
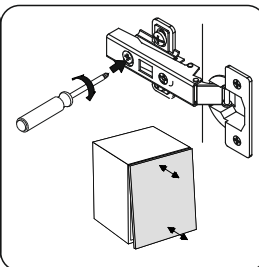
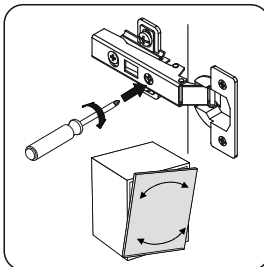

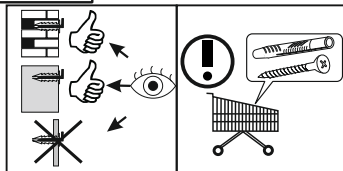
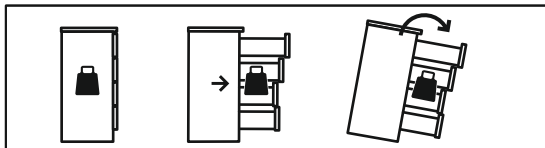

**PL**

#### OSTRZEŻENIE!

Przewrócenie się mebla może spowodować poważne lub śmiertelne obrażenia ciała na skutek przysięgnięcia.

ZAWSZE przymocuj ten mebel do ściany za pomocą ograniczników.

Kolek osadzony stosuje się do ścian z cegły i betonu. Do montażu na ścianie użyj łączników odpowiednich do materiału, z którego wykonana jest ściana, jeśli nie masz pewności, który rodzaj mocowania jest odpowiedni dla materiału ściennego, skontaktuj się ze specjalistą lub specjalistycznym sklepem. Ostatecznie za elementy złączne odpowiedzialny jest instalator.

Aby dodatkowo ograniczyć ryzyko poważnych obrażeń ciała i śmierci na skutek przewrócenia się mebla:

- Najcięższe przedmioty umieść w dolnej szufladzie. - Nie kładź na wierzchu ciężkich przedmiotów. - Nigdy nie pozwalaj dzieciom wspiąć się na szuflady, drzwiczki lub półki. - Używaj mebli zgodnie z ich przeznaczeniem.

**DE**

#### WARNUNG!

Beim Herunterfallen eines Möbelstücks kann es zu schweren oder tödlichen Verletzungen durch Quetschen kommen.

Befestigen Sie dieses Möbelstück IMMER mit den Begrenzern an der Wand.

Der eingebettete Stift wird für Ziegel- und Betonwände verwendet. Verwenden Sie für die Wandmontage Befestigungsmittel, die für das Wandmaterial geeignet sind, wenn Sie sich nicht sicher sind, welche Art der Befestigung für das Wandmaterial geeignet ist, wenden Sie sich an einen Fachmann oder Fachhandel. Der Installateur ist letztendlich für die Befestigungsmittel verantwortlich.

Um das Risiko von schweren Körperverletzungen und Tod durch umfallende Möbel weiter zu verringern:

- Legen Sie die schwersten Gegenstände in die unterste Schublade. - Nicht auf schwere Gegenstände stellen. - Lassen Sie Kinder niemals auf Schubläden, Türen oder Regale klettern. - Verwenden Sie die Möbel bestimmungsgemäß.

**EN**

#### WARNING!

The fall of a piece of furniture may cause serious or fatal injuries as a result of crushing.

ALWAYS fix this piece of furniture to the wall with the limiters.

The embedded pin is used for brick and concrete walls. For wall mounting, use fasteners suitable for the wall material, if you are unsure which type of fastening is appropriate for the wall material, contact a specialist or specialist shop. The installer is ultimately responsible for the fasteners.

To further reduce the risk of serious bodily injuries and death as a result of the furniture falling over:

- Place the heaviest items in the bottom drawer. - Do not put on top of heavy items. - Never allow children to climb on drawers, doors or shelves. - Use the furniture for its intended purpose.

**SPA**

#### ¡ADVERTENCIA!

La caída de un mueble puede provocar lesiones graves o mortales por aplastamiento.

Fije SIEMPRE este mueble a la pared con los limitadores.

El pasador incrustado se utiliza para paredes de ladrillo y hormigón. Para el montaje en la pared, utilice fijaciones adecuadas para el material de la pared, si no está seguro de qué tipo de fijación es adecuada para el material de la pared, póngase en contacto con un especialista o tienda especializada. El instalador es el responsable final de las fijaciones.

Para reducir aún más el riesgo de lesiones corporales graves y la muerte como resultado de la caída de los muebles:

- Coloque los elementos más pesados en el cajón inferior. - No poner encima de objetos pesados. - Nunca permita que los niños se suban a cajones, puertas o estantes. - Utilizar los muebles para el fin previsto.

**FR**

#### AVERTISSEMENT!

La chute d'un meuble peut entraîner des blessures graves ou mortelles par écrasement.

Fixez TOUJOURS ce meuble au mur avec les limiteurs.

La goupille encastrée est utilisée pour les murs en brique et en béton. Pour le montage mural, utilisez des fixations adaptées au matériau du mur, si vous n'êtes pas sûr du type de fixation adapté au matériau du mur, contactez un spécialiste ou un magasin spécialisé. L'installateur est responsable en dernier ressort des fixations.

Pour réduire davantage le risque de blessures corporelles graves et de décès à la suite de la chute des meubles :

- Placez les objets les plus lourds dans le tiroir du bas. - Ne pas mettre sur des objets lourds. - Ne laissez jamais les enfants grimper sur les tiroirs, les portes ou les étagères. - Utiliser le meuble conformément à sa destination.